

**2015-2017 BEACH DOMESTIC
COMPETITION REGULATIONS
as Presented by USA Volleyball**

Rules of the Game as authorized by the International Volleyball Federation at the XXXIVth FIVB Congress, Cagliari, Italy, 2014 and amended.

Editor: Kinda S. Lenberg
Assistant Editor: Rick Laskey

Published by USA Volleyball

USA Volleyball has officially approved the modifications presented in this document in order to promote the sport and encourage continuity of play at all levels across our country at the various organizational, local and recreational levels. For the official international rules of the game, which are used worldwide and developed and approved by the FIVB (Federation Internationale de Volleyball), please visit www.fivb.org or our web page at www.usavolleyball.org.

Printed by FuseCreates, Denver, Colo.

USA Volleyball
4065 Sinton Rd., Ste 200
Colorado Springs, CO 80907
(719) 228-6800
www.usavolleyball.org

Copyright © 2015 by USA Volleyball
ISBN: 0-9704491-1-9



Printed on 10% post-consumer waste recycled paper



Volleyball Associations/Federations worldwide endeavor to provide equal opportunities and maximum enjoyment for participants and spectators, maintaining the values of fair play and peaceful involvement.

USA Volleyball embraces this view, joining with all of its global partners to enable pleasurable participation from the broadest base of recreational play, to the highest levels of international competition. Volleyball can enrich the lives of all who play and watch it. It should be fun.

WE COMMIT THE RULES TO THIS END.



ACKNOWLEDGMENTS

The Rules Commission and USA Volleyball would like to express their appreciation to the many individuals and organizations for their assistance in the editing of and providing information for this publication.

Official Hand Signals courtesy of the Federation Internationale de Volleyball, © 2014 FIVB.

Diagrams 1-10 reproduced by authorization of the Federation Internationale de Volleyball, ©2014, FIVB.

Special thanks go to Steve Owen, Suzanne Lowry, Kim and Steve Kenyon, Tony Chan, Ryan MacDowell, Katy Meyer, Dan Apol, Keith Murlless and Connie Laskey.

Suggested Retail Price: \$6.95

BEACH VOLLEYBALL RULES
COVER DESIGN BY DESIGN RANGERS, INC.

TABLE OF CONTENTS

USA International and National Beach Officials Commission	Page vii
Significant Beach Rule Changes and Clarifications	viii
Introduction	B-1

OFFICIAL BEACH VOLLEYBALL DOMESTIC COMPETITION REGULATIONS

Chapter One: Facilities and Equipment	
Rule 1. Playing Area	B-4
Rule 2. Net and Posts	B-5
Rule 3. Balls	B-8
Chapter Two: Participants	
Rule 4. Teams	B-9
Rule 5. Team Leaders	B-11
Chapter Three: Playing Format	
Rule 6. To Score a Point, to Win a Set and the Match	B-12
Rule 7. Structure of Play	B-13
Chapter Four: Playing Actions	
Rule 8. States of Play	B-16
Rule 9. Playing the Ball	B-16
Rule 10. Ball at the Net	B-18
Rule 11. Player at the Net	B-19
Rule 12. Service	B-20
Rule 13. Attack-Hit	B-22
Rule 14. Block	B-23
Chapter Five: Interruptions, Delays and Intervals	
Rule 15. Interruptions	B-25
Rule 16. Game Delays	B-26
Rule 17. Exceptional Game Interruptions	B-26
Rule 18. Intervals and Change of Courts/Switches	B-28

Chapter Six: Participants' Conduct	
Rule 19. Requirements of Conduct	B-29
Rule 20. Misconduct and Its Sanctions	B-29

PART 2, SECTION 2
THE REFEREES, THEIR RESPONSIBILITIES AND OFFICIAL
HAND SIGNALS
OFFICIAL BEACH VOLLEYBALL RULES
2015-2017

Chapter Seven: Referees	
Rule 21. Refereeing Corps and Procedures	B-32
Rule 22. 1st Referee	B-33
Rule 23. 2nd Referee	B-34
Rule 24. Scorer	B-36
Rule 25. Assistant Scorer	B-37
Rule 26. Line Judges	B-38
Rule 27. Official Signals	B-39
Official Diagrams	B-40
Misconduct Sanction Scale	B-46
Referees' Hand Signals (Beach)	B-48
Line Judges' Official Flag Signals (Beach)	B-55
Definitions	B-57
Instructions for Use of the Official USA Volleyball Beach Volleyball Score Sheets	B-59
USAV Guidelines for Three-Player (Triples), Four-Player (Quads), Six-Player (Sixes), Including Co-Ed & Reverse Co-Ed	B-76
Abbreviations	B-78
Metric Conversions	B-79
Guidelines for Beach (Outdoor) Volleyball Tournaments	B-80
Guide to Physically Challenged Beach Volleyball	B-83
Index to the Rules	
Official Outdoor Rules	B-84
Outdoor Scoring Instructions	B-111
Guidelines for Outdoor Tournaments	B-111

INFORMATION FOR HEARING-IMPAIRED VOLLEYBALL PLAYERS

For additional information on the USA Deaf Volleyball Association or USA Deaf Sports Federation, contact:

Patrick O'Brien

PO Box 2193, Bowie, MD 20718-2193

Email: pobrien@usadeafsports.org

or

USA Deaf Sports Federation

PO Box 910338, Lexington, KY 40591-0338

E-mail: homeoffice@usdeafsports.org

Web Site: www.usdeafsports.org/volleyball

TT (605) 367-5761, (605) 367-5760, FAX: (605) 782-8441

Dial 711 for voice calls and give relay operator the TT number above

To obtain a copy of Volleyball in American Sign Language, which illustrates more than 40 of the most important volleyball terms, contact USA Volleyball at 855-USVOLLEY or info@usav.org.

INFORMATION FOR PHYSICALLY CHALLENGED VOLLEYBALL PLAYERS

For additional information on the Men's and Women's Standing and Sitting Volleyball National Programs for the physically challenged contact:

Bill Hamiter, High Performance Director, Sitting Program

Head Coach Women's National Sitting Team

100 N. University Dr., Box 99

Edmond, OK 73034

Phone: (405) 974-3138, FAX: (405) 974-3808

E-mail: bill.hamiter@usav.org

For additional information on grassroots programs (find a place to play, create a new program, etc.), contact:

Elliott Blake, Sitting Volleyball Coordinator

100 N. University Dr., Box 99

Edmond, OK 73034

Phone: (405) 974-3153, FAX: (405) 974-3808

Email: elliott.blake@usav.org

CHANGES

Suggestions for additional changes or temporary adjustments for inclusion in this document may be transmitted through members of the Rules Commission, regional officials, chairpersons or commissioners during the season. Explanation and rationale of proposed modifications must be in the chair's hands before **Feb. 1, 2016**, if they are to be considered at the annual meeting of the Rules Commission and before **Feb. 1, 2017** if they are to be considered at the 2017 annual meeting.

RULES INTERPRETATION

Questions regarding interpretation of the present rules and current practices may be addressed to:

USA Beach Volleyball Rules
Interpreter E-mail: Beachinterp@usav.org

Enclose a self-addressed, stamped envelope with your inquiry for prompt return. All inquiries will receive replies. Because of the translation of international rules, some queries may involve consultations, but answers will be forwarded as soon as possible.

For information relevant to the interpretation and application of the rules-specific match situations, please consult the USA Volleyball web site at **www.usavolleyball.org**

INFORMATION FOR SPECIAL OLYMPICS VOLLEYBALL PLAYERS

For additional information on Special Olympics four-person Beach Volleyball, please contact:

Special Olympics North America

Craig Pippert
3712 Benson Dr., Suite 102
Raleigh, NC 27609
(919) 785-0702, FAX: (919) 782-3311
Email: cpippert@specialolympics.org

**USA INTERNATIONAL AND NATIONAL BEACH
OFFICIALS COMMISSION
2015-2017**

Chair, International/National Beach Official Commission:

Steve Owen, 894 Elmwood Drive, Abilene, TX 79605
(Phone: Res: 325-676-0721, Cell: 325-668-3484,
Email: swowen2@suddenlink.net)

**Director for National Beach Officials Certification and
Evaluation:** Keith Murlless, 5805 Sharon Rd., Apt. F, Charlotte, NC
28210 (Cell: 828-280-7170, Email: kmurlless@gmail.com)

Director of RVA Beach Officials Development: Steve Kenyon,
2661 Shaw Road, Marietta, GA 30066 (Phone: 770-565-8867,
Cell: 770-329-7823, Email: skenyon.vbref@gmail.com)

Director of Beach Officials Materials & Training: Suzanne
Lowry, 5805 Sharon Rd., Apt. F, Charlotte, NC 28210
(Cell: 843-224-0968, Email: suzannelowry@msn.com)

USA Beach Volleyball Rules Interpreter: Glenn Sapp,
7950 Dudley Ct., Arvada, CO 80005 (Cell: 720-289-5797,
Work: 303-679-5202, E-mail: sappvb@aol.com)

At-Large RVA Beach Representative: Ryan MacDonald,
PO Box 5328, Englewood, CO 80155 (Cell: 303-912-0806,
Email: rymacdow@aol.com)

**Beach Officials Representative to the USAV Beach
Assembly:** Katrina Meyer, 745 Kalimera Cir., Prescott, AZ 86301-7600
(Cell: 602-363-9190, Email: katy.meyer@me.com)

MEMBER ORGANIZATION BEACH CONTACTS

AAU: Gino Grajeda, P.O. Box 3177, Manhattan Beach, CA
90266 (Phone: 310-344-4466, Email: ggrajeda181@msn.com)

2015-2017 DOMESTIC COMPETITION REGULATIONS

SIGNIFICANT BEACH RULE CHANGES AND CLARIFICATIONS

4.5.3 Compression pads (padded injury protection devices) may be worn for protection or support.

For FIVB, World and Official Competitions for seniors, these devices must be of the same color as part of the uniform.

6.1.3 Rally and completed rally

A rally is the sequence of playing actions from the moment of the service hit by the server until the ball is out of play. A completed rally is the sequence of playing actions which results in the award of a point. This includes the award of a penalty and loss of service for serving faults outside the time limit.

11.3 CONTACT WITH THE NET

11.3.1. Contact with the net by a player between the antennae, during the action of playing the ball, is a fault.

The action of playing the ball includes (among others) take-off, hit (or attempt) and landing.

11.4 PLAYER'S FAULTS AT THE NET

11.4.4. A player interferes with play by (amongst others):

- touching the net between the antennae or the antenna itself during his/her action of playing the ball,
- using the net between the antennae as a support or stabilizing aid,
- creating an unfair advantage over the opponent by touching the net,
- making actions which hinder an opponent's legitimate attempt to play the ball,
- catching/ holding on to the net.

Players close to the ball as it is played, or who are trying to play it, are considered in the action of playing the ball, even if no contact is made with the ball.

However, touching the net outside the antenna is not to be considered a fault (except for Rule 9.1.3).

21.2.3.1 if the fault is whistled by the 1st referee, he/she will indicate in order:

- a) the team to serve,
- b) the nature of the fault,
- c) the player(s) at fault (if necessary).

~~The 2nd referee will follow the 1st referee's hand signals by repeating them.~~

21.2.3.3 In the case of a double fault both referees indicate in order

- a) the nature of the fault,
- b) the players at fault (if necessary).

The team to serve next is then indicated by the 1st referee.

New USAV 4.1.4.3: may perform drills with their team on court until the conclusion of the coin toss;

New USAV 4.1.4.4: during the official timed warm up may only instruct their players from the sideline;

New USAV 4.1.4.6: must remain seated/kneeling in their players' area (switching sides with their team);

New USAV 4.1.4.7: may suggest to the team captain in a non-disruptive manner, the request for time-out and are permitted to request time-out for all competition U-19 and below;

New USAV 17.2: The referees, TV staff and auxiliary officials within the free zone in their normal working positions are considered as part of the court. They shall not be considered the cause of external interference unless they initiate the contact (or threat of contact) with the player and/or the ball. Spectators are not a part of the court, therefore if they hinder a legitimate attempt to play the ball, a replay should be granted. For courts that do not have a clearly defined free-zone, the referees should identify the playing area during the pre-match captains' meeting.



USAVolleyball[®]

For All Your Officiating Needs,
Contact USA Volleyball:

USAV New Score Sheet Layout	\$5.00
USAV Condensed Layout Score Sheets	\$10.00
Line-Up Sheets (pad of 50)	\$10.00
2015-17 Domestic Competition Regulations (Rulebook)	\$6.95
Libero Tracking Sheets (pad of 50)	\$5.00

Prices do not include shipping & handling.

Phone: (512) 479-5130

(Between 9 a.m. and 5 p.m. Central)

E-mail: em2sports@yahoo.com

**2015-2017 BEACH DOMESTIC COMPETITION
REGULATIONS (Including all Formats of Sand
and Grass Outdoor Volleyball)
as Presented by USA VOLLEYBALL**

Beach Volleyball is a sport played by two teams of two players each on a sand court divided by a net. There are different versions available for specific circumstances in order to offer the versatility of the game to everyone.

The object of the game is to send the ball over the net in order to ground it on the opponent's court, and to prevent the same effort by the opponent. The team has three hits for returning the ball (including the block touch).

The ball is put in play with a service: hit by the server over the net to the opponents. The rally continues until the ball is grounded on the playing court, goes "out" or a team fails to return it properly.

In Beach Volleyball, the team winning a rally scores a point (Rally Point System). When the receiving team wins a rally, it gains a point and the right to serve. The serving player must be alternated every time this occurs.

USAV Guidelines for Three-Player (Triples), Four-Player (Quads), Six-Player (Sixes), including Co-Ed & Reverse, can be found on page B-76.

Philosophy of Rules and Refereeing

Introduction

Beach Volleyball is one of the most successful and popular competitive and recreational sports in the world. It is fast, it is exciting and the action is explosive. Yet the Beach form of Volleyball comprises several crucial overlapping elements whose complementary interactions render it unique among rally games:

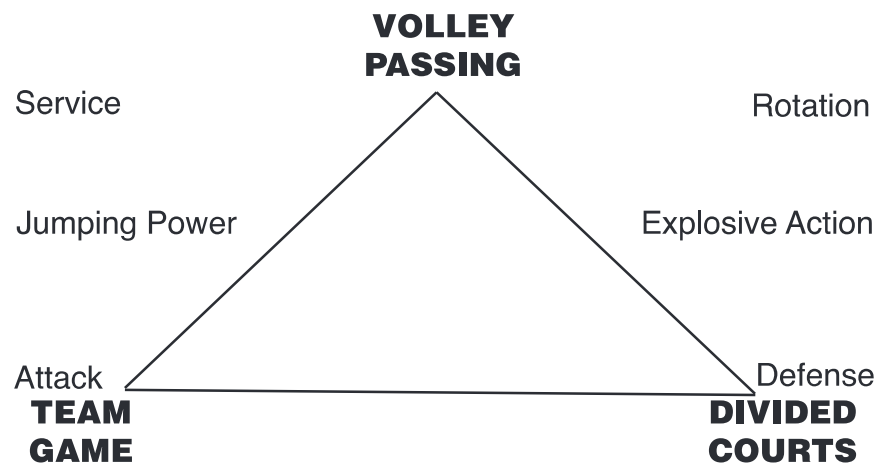

In recent years, the FIVB has made great strides in adapting the game to a modern audience.

This text is aimed at a broad volleyball public – players, coaches, referees, spectators or commentators – for the following reasons:

- Understanding the rules better allows better play – coaches can create better team structure and tactics, allowing players full rein to display their skills;
- Understanding the relationship between rules allows officials to make better decisions.

This introduction at first focuses on Beach Volleyball as a competitive sport, before setting out to identify the main qualities required for successful refereeing.

FIVB Beach Volleyball is a Competitive Sport

Competition taps latent strengths. It exhibits the best of ability, spirit, creativity and aesthetics. The rules are structured to allow **all** of these qualities. With a few exceptions, Beach Volleyball allows all players to operate both at the net (in attack) and in the back of the court (to defend or serve).

The game's early exponents on the sands of California would still recognize it because Beach Volleyball has retained certain distinctive and essential elements over the years. Some of these it shares with other

net/ball/racquet games:

- service
- rotation (taking turns to serve)
- attack
- defense.

Beach Volleyball is, however, unique amongst net games in insisting that the ball is in constant flight – a flying ball – and by allowing each team a degree of internal passing before the ball must be returned to the opponents.

Modifications to the service rule have changed the act of service from simply a means of putting the ball in play to an offensive weapon.

The concept of “rotation” is entrenched to allow for all-around athletes. The rules on player positions must permit teams to have flexibility and to create interesting developments in tactics. Competitors use this framework to contest techniques, tactics and power. The framework also allows players a freedom of expression to enthuse spectators and viewers.

And the image of Beach Volleyball is increasingly a good one.

The Referee Within This Framework

The essence of a good referee lies in the concept of fairness and consistency:

- To be fair to every participant;
- To be viewed as fair by the spectators.

This demands a huge element of trust – the referee must be trusted to allow the players to entertain:

- by being accurate in his/her judgment;
- by understanding why the rule is written;
- by being an efficient organizer;
- by allowing the competition to flow and by directing it to a conclusion;
- by being an educator – using the rules to penalize the unfair or admonish the impolite;
- by promoting the game – that is, by allowing the spectacular elements in the game to shine and the best players to do what they do best: entertain the public.

Finally, we can say that a good referee will use the rules to make the competition a fulfilling experience for all concerned.

To those who have read thus far, view the Rules that follow as the current state of development of a great game, but keep in mind why these preceding few paragraphs may be of equal importance to you in your own position within the sport.

Get involved!
Keep the ball flying!

DOMESTIC COMPETITION REGULATIONS

CHAPTER 1 FACILITIES AND EQUIPMENT

See Rules

1. PLAYING AREA

The playing area includes the playing court and the free zone. It shall be rectangular and symmetrical.

1.1, D1

1.1 DIMENSIONS

1.1.1 The playing court is a rectangle measuring 16 x 8 m (52'6" x 26'3"), surrounded by a free zone, which is a minimum of 3 m (9'10") wide on all sides. The free playing space is the space above the playing area, which is free from all obstructions. The free playing space shall measure a minimum of 7 m (23') in height from the playing surface.

D2

USAV 1.1.1: The court dimensions for each team's side are 8 x 8 m (26'3") square court. The length of each short diagonal is subsequently 11.31 m (37'1") and that of the long diagonal is 17.89 m (58'8"). For court dimensions for four-player and six-player competition, please refer to the conversion chart on page B-79.

1.1.2 **For FIVB World and Official Competitions, the free zone is a minimum of 5 m (16') and a maximum of 6 m (20') from the end lines/ side lines. The free playing space shall measure a minimum of 12.5 m (41') in height from the playing surface.**

1.2 PLAYING SURFACE

1.2.1 The surface must be composed of leveled sand, as flat and uniform as possible, free of rocks, shells and anything else which can represent risks of cuts or injuries to the players.

1.2.2 **For FIVB World and Official Competitions, the sand must be at least 40 cm (15^{3/4}") and composed of fine, loosely compacted grains.**

1.2.3 The playing surface must not present any danger of injury to the players.

1.2.4 **For FIVB World and Official Competitions, the sand should also be sifted to an acceptable size, not too coarse and free of stones and dangerous particles. It should not be too**

fine to cause dust and stick to the skin.

USAV 1.2.4: Grass courts shall consist of maintained grass surfaces that are free of holes, puddles and uneven ground.

- 1.2.5 **For FIVB, World and Official competitions, a tarp to cover the central court is recommended in case of rain.**

1.3 LINES ON THE COURT

D2

- 1.3.1 All lines are 5 cm (2") wide. The lines must be of a color which contrasts sharply with the color of the sand.

USAV 1.3.1: Rope lines of .5 cm to 1 cm (3/16 to 3/8") may also be used.

- 1.3.2 Boundary lines
Two side lines and two end lines mark the playing court. There is no center line. Both side and end lines are placed inside the dimensions of the playing court. Court lines should be ribbons made of a resistant material, and any exposed anchors should be of a soft, flexible material.

1.4 ZONES AND AREAS

There is only the court service zone and the free zone surrounding the court.

- 1.4.1 The service zone is an 8 m (26'3") wide area behind the end line which extends to the edge of the free zone.

1.5 WEATHER

The weather must not present any danger of injury to the players.

1.6 LIGHTING

For FIVB World and Official Competitions, played at night, the lighting on the playing area should be 1,000 to 1,500 lux measured at 1 m (39") above the surface of the playing area.

2. NET AND POSTS

D3

2.1 HEIGHT OF THE NET

- 2.1.1 Placed vertically over the middle of the court there is a net whose top is set at the height of 2.43 (7'11^{5/8"}) for men and 2.24 m (7'4^{1/8"}) for women.

Note: The height of the net may be varied for specific age groups as follows:

Age Groups	Females	Males
16 years and under	2.24 m (7'4 ¹ / ₈ "	2.24 m (7'4 ¹ / ₈ "
14 years and under	2.12 m (6'11 ¹ / ₂ "	2.12 m (6'11 ¹ / ₂ "
12 years and under	2.00 m (6'6 ³ / ₄ "	2.00 m (6'6 ³ / ₄ "

USAV 2.1: The height of the net may be varied for specific age groups as follows:

Age Groups	Females	Males
16 years and under	*2.24 m (7'4 ¹ / ₈ "	*2.43 m (7'11 ⁵ / ₈ "
14 years and under	*2.24 m (7'4 ¹ / ₈ "	*2.24 m (7'4 ¹ / ₈ "
12 years and under	2.12 m (6'11 ¹ / ₂ "	2.12 m (6'11 ¹ / ₂ "

*same as adult height

2.1.2 Its height is measured from the center of the playing court with a measuring rod. The net height (over the two side lines) must be exactly the same and must not exceed the official height by more than 2 cm (3/4").

2.2 STRUCTURE

The net is 8.5 m (27'10¹/₂" long and 1 m (39") (+/-3 cm) (+/-1¹/₈" wide when it is hung taut, placed vertically over the narrow axis at the middle of the court. It is made of 10 cm (4") square mesh. At its top and bottom there are two 7-10 cm (1¹/₂-4") wide horizontal bands made of two-fold canvas, preferably in dark blue or bright colors, sewn along its full length. Each extremity of the upper band has a hole through which passes a cord fastening the upper band to the posts to keep the top of the net stretched taut.

Within the bands, there is a flexible cable in the upper one and a cord in the bottom one for fastening the net to the posts and keeping its top and bottom taut. It is permissible to have advertising on the horizontal bands of the net.

For FIVB, World and Official Competitions, an 8.0 m (26'3") net with smaller meshes and brandings displayed between the ends of the net and the posts may be used, provided that the visibility of the athletes and officials will be preserved. Publicity may be printed on the above items as per FIVB regulations.

D3

2.3 SIDE BANDS

Two colored bands, 5 cm (2") wide (same width as the court lines) and 1 m (39") long, are fastened vertically to the net and placed above each side line. They are considered part of the net. Advertising is permitted on the side bands.

USAV 2.3: The side bands are optional for USA competition.

14.1.1,
D3

2.4 ANTENNAE

An antenna is a flexible rod, 1.80 m (5'11") long and 10 mm (3/8") in diameter, made of fiberglass or similar material.

An antenna is fastened at the outer edge of each side band. The antennae are placed on opposite sides of the net.

The top 80 cm (32") of each antenna extends above the net and is marked with 10 cm (4") stripes of contrasting color, preferably red and white.

The antennae are considered as part of the net and laterally delimit the crossing space.

2.5 POSTS

2.5.1 The posts supporting the net are placed at a distance of 0.70-1.00 m (27^{1/2}"-39") from each side line to the post padding. They are 2.55 m (8'4") high and preferably adjustable.

For all FIVB World and Official Competitions, the posts supporting the net are placed at a distance of 1 m (39") outside the side lines.

2.5.2 The posts are rounded and smooth, fixed to the ground without wires. There shall be no dangerous or obstructing devices. Posts must be padded.

USAV 2.5.2: It is recommended that the posts be rounded, smooth and free of any sharp edges or protrusions that may cause injury to players. All protrusions that cannot be removed must be padded. Posts shall be padded to a minimum height of 1.7 m (5'6") with at least 1.25 cm (1/2") thick, resilient, shock-absorbing material. It is recommended that all guy lines that support posts from the playing surface be eliminated. If used, the guy ropes shall be made of bright colors or marked with flags, while any guide cables, rigid braces or wire supports must be padded using the same specifications as the net standards. Anchors for guy lines must be free of sharp edges and driven flush with or buried beneath the playing surface.

D2, D3

2.6 ADDITIONAL EQUIPMENT

All additional equipment is determined by FIVB regulations. USAV 2.6: A referee's platform is highly recommended. The platform may be either attached (to a permanently installed net standard), or may be free-standing. The platform should be adjustable in height, such that the referee's eye position shall be approximately 50 cm (19") above the top of the net. The platform should be constructed, positioned and padded such that it presents the least potential hazard for players while retaining maximal stability for the referee. Step ladders, jump boxes and other devices not specifically designed as referee platforms shall not be used. The front and sides of the referee's platform shall be padded to a minimum height of 1.7 m (5'6") with at least 1.25 cm (1/2") thick, resilient, shock-absorbing material.

3. BALLS

3.1 STANDARDS

The ball shall be spherical, made of a flexible material (leather, synthetic leather, or similar) which does not absorb moisture, i.e., more suitable to outdoor conditions since matches can be played when it is raining. The ball has a bladder inside made of rubber or similar material. Approval of synthetic leather material is determined by FIVB regulations. Color: light colors or a combination of colors
Circumference: 66 to 68 cm (25^{1/2}-27")
Weight: 260 to 280 g (9-10 oz.)
Inside pressure: 0.175 to 0.225 kg/cm² (171 to 221 mbar or hPa) (2.5 to 3.2 lb/sq in)

3.2 UNIFORMITY OF BALLS

All balls used in a match must have the same standards regarding circumference, weight, pressure, type, color, etc. **FIVB World and Official Competitions must be played with FIVB approved balls, unless by agreement of FIVB.**

3.3 THREE-BALL SYSTEM

For FIVB World and Official Competitions, three balls shall be used. In this case, six ball retrievers are stationed, one at each corner of the free zone and one behind each referee.

3.2

3.1,
26.2.7

D8

CHAPTER 2 PARTICIPANTS

See
Rules

4. TEAMS

4.1 TEAM COMPOSITION

USAV 4.1: A coach and no more than one assistant coach are permitted to participate in the match to promote athletic development.

4.1.1 A team is composed exclusively of two players.

USAV 3.1.1: A team is composed of both players and a coach(es).

4.1.2 Only the two players recorded on the score sheet have the right to participate in the match.

4.1.3 One of the players is the team captain, who shall be indicated on the score sheet.

4.1.4 **For FIVB World and Official Competitions, players are not allowed to receive external assistance or coaching during a match.**

USAV 4.1.4: Coaching is permitted under the following guidelines. Coaches:

USAV 4.1.4.1: must be identified as a coach and dress professionally (at minimum, in shirt and shorts);

USAV 4.1.4.2: may not address the officials or attempt to influence their decisions at any time;

USAV 4.1.4.3: may perform drills with their team on court until the conclusion of the coin toss;

USAV 4.1.4.4: during the official timed warm up may only instruct their players from the sideline;

USAV 4.1.4.5: during the match may give instruction only during time-outs, court switches and between sets;

USAV 4.1.4.6: must remain seated/kneeling in their players' area (switching sides with their team);

USAV 4.1.4.7: may suggest to the team captain in a non-disruptive manner, the request for time-out and are permitted to request time-out for all competition U-19 and below;

USAV 4.1.4.8: are subject to sanction (individual misconduct or delay) for inappropriate behavior or delay of the match. (See diagram 7c.)

4.2 LOCATION OF THE TEAM

- 4.2.1 The team's areas (including two chairs each) must be 5 m (16'^{3/4}) from the sideline, and no closer than 3 m (9'10") from the scorer's table.

4.3 EQUIPMENT

A player's equipment consists of shorts or a bathing suit. A jersey or "tank-top" is optional except when specified in Tournament Regulations. Players may wear a hat/head covering.

- 4.3.1 **For FIVB, World and Official Competitions, players of a given team must wear uniforms of the same color and style according to tournament regulations. Players' uniforms must be clean.**

4.3.2 Players must play barefoot except when authorized by the 1st referee.

4.3.3 Players' jerseys (or shorts if players are allowed to play without shirt) must be numbered 1 and 2.

USAV 4.3.3: Players' shirts or shorts do not require numbers for USA competition.

4.3.3.1 The number must be placed on the chest (or on the front of the shorts).

4.3.3.2 The numbers must be of a contrasting color to the jerseys and a minimum of 10 cm (4") in height. The stripe forming the numbers shall be a minimum of 1.5 cm (1/2") wide.

4.4 CHANGE OF EQUIPMENT

If both teams arrive at a match dressed in jerseys of the same color, a toss shall be conducted to determine which team shall change.

The first referee may authorize one or more players:

4.4.1 to play with socks and/or shoes;

USAV 4.4.1: For USAV grass competition, players may wear safe, tournament-approved shoes.

4.4.2 to change wet jerseys between sets provided that the new ones also follow tournament and FIVB regulations.

4.4.3 If requested by a player, the 1st referee may authorize him/her to play with undershirts and training pants.

4.5 FORBIDDEN OBJECTS

4.5.1 It is forbidden to wear objects which may cause injury, or give an artificial advantage to the player.

4.5.2 Players may wear glasses or lenses at their own risk.

4.5.3 Compression pads (padded injury protection devices)

may be worn for protection or support.

For FIVB, World and Official Competitions for Seniors, these devices must be of the same color as the corresponding part of the uniform.

5. TEAM LEADERS

The team captain is responsible for maintaining team conduct and discipline.

5.1 CAPTAIN

- 5.1.1 PRIOR TO THE MATCH, the team captain: a) signs the score sheet; b) represents his/her team in the toss.
- 5.1.2 DURING THE MATCH, only the captain is authorized to speak to the referees while the ball is out of play in the following three cases:
 - 5.1.2.1 to ask for an explanation on the application or interpretation of the Rules; if the explanation does not satisfy the captain, the captain must immediately inform the 1st referee of his/her wish to Protest;
 - 5.1.2.2 to ask authorization:
 - a) to change uniforms or equipment,
 - b) to verify the number of the serving player,
 - c) to check the net, the ball, the surface, etc.,
 - d) to realign a court line;
 - 5.1.2.3 to request time-outs.
Note: The players must have authorization from the referees to leave the playing area.
- 5.1.3 AT THE END OF THE MATCH:
 - 5.1.3.1 Both players thank the referees and the opponents. The Captain signs the score sheet to ratify the result.
USAV 5.1.3.1: For USAV competition, no post-match signature is required (see also USAV 24.2.3.3).
 - 5.1.3.2 If the captain previously requested a Protest Protocol via the 1st referee and this has not been successfully resolved at the time of the occurrence he/she has the right to confirm it as a formal written protest, recorded on the score sheet at the end of the match.

8.2

15.2.1,
15.4.1

5.1.2.1

CHAPTER 3 PLAYING FORMAT

6. TO SCORE A POINT, TO WIN A SET AND THE MATCH	See Rules
6.1 TO SCORE A POINT	
6.1.1 Point	
A team scores a point	
6.1.1.1 by successfully grounding the ball on the opponent's court;	D9(14)
6.1.1.2 when the opponent team commits a fault;	
6.1.1.3 when the opponent team receives a penalty.	
6.1.2 Fault	
A team commits a fault by making a playing action contrary to the rules (or by violating them in some other way). The referees judge the faults and determine the consequences according to the Rules:	
6.1.2.1 If two or more faults are committed successively, only the first one is counted.	
6.1.2.2 If two or more faults are committed by opponents simultaneously, a DOUBLE FAULT is called and the rally is replayed.	D9(23)
6.1.3 Rally and completed rally	
A rally is the sequence of playing actions from the moment of the service hit by the server until the ball is out of play. A completed rally is the sequence of playing actions, which results in the award of a point. <u>This includes the award of a penalty and loss of service for serving faults outside the time limit.</u>	8.1, 8.2, 12.2.2.1, 12.4.4, 22.3.2.2
6.1.3.1 if the serving team wins a rally, it scores a point and continues to serve;	
6.1.3.2 if the receiving team wins a rally, it scores a point and it must serve next.	
6.2 TO WIN A SET	
A set (except the deciding, 3 rd set) is won by the team which first scores 21 points with a minimum lead of two points. In the case of a 20-20 tie, play is continued until a two-point lead is achieved (22-20; 23-21; etc.).	D9(9)
6.3 TO WIN THE MATCH	
6.3.1 The match is won by the team that wins two sets.	D9(9)
6.3.2 In the case of a 1-1 tie, the deciding 3 rd set is played to 15 points with a minimum lead of 2 points.	

6.4 DEFAULT AND INCOMPLETE TEAM

- 6.4.1 If a team refuses to play after being summoned to do so, it is declared in default and forfeits the match with the result 0-2 for the match and 0-21 for each set.
- 6.4.2 A team that does not appear on the playing court on time is declared in default. 6.4.1

USAV 6.4.2: For USAV competition, if one team is not present at the match start time, the first set is forfeited, 0-21, by that team. If the team has not arrived within 10 additional minutes the second set (0-21) and thus the match (0-2), is forfeited. Teams arriving within the 10-minute interval may make use of whatever time remains for warm-up.

Note: Forfeits are generally subject to the tournament director's discretion. Whenever possible, consult the director as soon as it becomes evident that a team is not present. Consult the director again prior to declaring a forfeit.

- 6.4.3 A team that is declared INCOMPLETE for the set or for the match loses the set or the match. The opponent team is given the points, or the points and the sets, needed to win the set or the match. The incomplete team keeps its points and sets. 6.2, 6.3, 7.3.1

For FIVB, World and Official Competitions, whenever the Pool Play format is implemented, Rule 6.4 above may be subject to modifications as stated in the Specific Competition Regulations issued by the FIVB in due time, establishing the modality to be followed for treating the default and incomplete team cases.

7. STRUCTURE OF PLAY

7.1 THE TOSS

Before the official warm up, the 1st referee conducts the coin toss to decide upon the first service and the sides of the court in the first set.

- 7.1.1 The toss is taken in the presence of the two team captains, where appropriate.
- 7.1.2 The winner of the toss chooses:
EITHER
- 7.1.2.1 the right to serve or to receive the service,
 - 7.1.2.2 OR the side of the court. The loser takes the remaining choice.

- 7.1.2.3 In the second set the loser of the toss in the first set will have the choice of 7.1.2.1 or 7.1.2.2.
A new toss will be conducted for the deciding set.

7.2 OFFICIAL WARM-UP SESSION

Prior to the match, if the teams have previously had another playing court at their disposal, they will have a 3-minute official warm-up period at the net; if not, they may have 5 minutes.

7.3 TEAM STARTING LINE-UP

- 7.3.1 Both players of each team must always be in play. 4.1.1

7.4 POSITIONS

At the moment the ball is hit by the server, each team must be within its own court (except the server).

- 7.4.1 The players are free to position themselves.
There are NO determined positions on the court.

7.5 POSITIONAL FAULT

- 7.5.1 There are NO positional order faults.

7.6 SERVICE ORDER

- 7.6.1 Service order is must be maintained throughout the set (as determined by the team captain immediately following the toss).
- 7.6.2 When the receiving team has gained the right to serve, its players “rotate” one position.

7.7 SERVICE ORDER FAULT

- 7.7.1 A service order fault is committed when the service is not made according to the service order. The team is sanctioned with a point and service to the opponent. D9(13)
- 7.7.2 The scorer(s) must correctly indicate the service order and correct any incorrect server.

USAV 7.7: For Doubles Competition only: If an incorrect player attempts to serve, the scorer and the referees shall prevent the error prior to service. Should the error be discovered after the ball has been put into play, the 2nd referee shall stop play and allow the correct player to serve. Should the incorrect server not be discovered until after points were scored, the service order is merely corrected with team(s) maintaining their points and a new service made. If a scorer is available the scorer shall attempt to correct any

error in service order prior to the service contact. See also Rule 7.6.

Note: Only when a player insists on serving out of order will a service fault occur.

CHAPTER 4 PLAYING ACTIONS

8. STATES OF PLAY

See Rules

8.1 BALL IN PLAY

The ball is in play from the moment of the hit of the service authorized by the 1st referee. 12, 12.3

8.2 BALL OUT OF PLAY

The ball is out of play at the moment of the fault, which is whistled by one of the referees; in the absence of a fault, at the moment of the whistle.

8.3 BALL "IN"

The ball is "in" when it touches the surface of the playing court including the boundary lines. D9(14), D10(1)

8.4 BALL "OUT"

The ball is "out" when it:

- 8.4.1 falls on the ground completely outside the boundary lines (without touching them); 1.3.2, D9(15), D10(2)
- 8.4.2 touches an object outside the court or a person out of play; D9(15), D10(4)
- 8.4.3 touches the antennae, ropes, posts or the net itself outside the side bands; 2.3, D3, D4a, D9(15), D10(4)
- 8.4.4 crosses the vertical plane of the net either partially or totally outside the crossing space during service or during the third hit of the team (exception: Rule 10.1.2); 2.3, 10.1.2, D4a, D9(15), D10(4)
- 8.4.5 crosses completely the lower space under the net. D4a, D9(22)

9. PLAYING THE BALL

Each team must play within its own playing area and playing space (except Rule 10.1.2). The ball may, however, be retrieved from beyond the free zone. 10.1.2

9.1 TEAM HITS

A hit is any contact with the ball by a player in play. Each team is entitled to a maximum of three hits for returning the ball over the net. If more are used, the team commits the

fault of: "FOUR HITS."

These team hits include not only intentional hits by the player, but also unintentional contacts with the ball.

9.1.1 CONSECUTIVE CONTACTS

A player may not hit the ball two times consecutively (except Rules 9.2.3, 14.2 and 14.4.2). 9.2.3, 14.2, 14.4.2, D9(17)

9.1.2 SIMULTANEOUS CONTACTS

Two players may touch the ball at the same moment.

9.1.2.1 When two teammates touch the ball simultaneously, it is counted as two hits (with the exception of blocking). If they reach for the ball, but only one of them touches it, one hit is counted. If players collide, no fault is committed. 14.2

9.1.2.2 When two opponents touch the ball simultaneously over the net and the ball remains in play, the team receiving the ball is entitled to another three hits. If such a ball goes "out," it is the fault of the team on the opposite side.

9.1.2.3 If simultaneous hits by two opponents over the net lead to extended contact with the ball, play continues. 9.1.2.2

9.1.3 ASSISTED HIT

Within the playing area, a player is not permitted to take support from a teammate or any structure/object in order to hit the ball.

However, a player who is about to commit a fault (touch the net or interfere with an opponent, etc.) may be stopped or held back by a teammate.

9.2 CHARACTERISTICS OF THE HIT

9.2.1 The ball may touch any part of the body.

9.2.2 The ball must not be caught and/or thrown. It can rebound in any direction. 9.3.3

Exceptions:

9.2.2.1 in defensive action of a hard-driven ball. In this case, the ball contact can be extended momentarily overhand with the fingers;

USAV 9.2.2.1: As well as doubled with fingers.

9.2.2.2 if simultaneous contact with the ball over the net by the two opponents leads to an extended contact.

9.2.3 The ball may touch various parts of the body, provided that the contacts take place simultaneously.

Exceptions:

- 9.2.3.1 at blocking, consecutive contacts may be made by one or more players, provided that they occur during one action; 14.2
- 9.2.3.2 at the first hit of the team, unless it is played overhand using fingers (exception Rule 9.2.2.1), the ball may contact various parts of the body consecutively, provided that the contacts occur during one action. 9.2.2.1

USAV 9.2.3.2: Plays involving finger action require special attention. If the play is defensive and reactive in nature, as in the case of a hard-driven ball, momentarily held or double-contacted balls are not considered faults.
Furthermore, this may apply to the second touch of a team if the block contact was slight and the ball is still a hard-driven attack or to the defensive action (team first contact) after a ball has been blocked. If the player decides/intends to use finger setting action to contact an off-speed attack, the contact must be “clean.”

9.3 FAULTS IN PLAYING THE BALL

- 9.3.1 FOUR HITS: a team hits the ball four times before returning it. 9.1, D9(18)
- 9.3.2 ASSISTED HIT: a player takes support from a teammate or any structure/object in order to hit the ball within the playing area. 9.1.3
- 9.3.3 CATCH: the ball is caught and/or thrown; it does not rebound from the hit. (Exceptions 9.2.2.1, 9.2.2.2.) 9.2.2.1, 9.2.2.2, D9(16)
- 9.3.4 DOUBLE CONTACT: a player hits the ball twice in succession or the ball contacts various parts of his/her body in succession. 9.1.1, 9.2.3, D9(17)

10. BALL AT THE NET

10.1 BALL CROSSING THE NET

- 10.1.1 The ball sent to the opponent’s court must go over the net within the crossing space. The crossing space is the part of the vertical plane of the net limited as follows: D4a
 - 10.1.1.1 below, by the top of the net;
 - 10.1.1.2 at the sides, by the antennae, and their imaginary extension;
 - 10.1.1.3 above, by the ceiling or structure (if any).

- 10.1.2 The ball that has crossed the net plane to the opponent's free zone totally or partly through the external space may be played back within the team hits, provided that:
 - 10.1.2.1 The ball when played back crosses the vertical plane of the net again totally, or partly through the external space on the same side of the court.
The opponent may not prevent such action.
- 10.1.3 The ball is "out" when it crosses completely the lower space under the net.
- 10.1.4 A player, however, may enter the opponents' court in order to play the ball before it crosses completely the lower space or passes outside the crossing space.

9.1,
D4b

D4b

10.1.3

10.2 BALL TOUCHING THE NET

- While crossing the net, the ball may touch it.

10.1.1

10.3 BALL IN THE NET

- 10.3.1 A ball driven into the net may be recovered within the limits of the three team hits.
- 10.3.2 If the ball rips the mesh of the net or tears it down, the rally is cancelled and replayed.

9.1

11. PLAYER AT THE NET

11.1 REACHING BEYOND THE NET

- 11.1.1 In blocking, a player may touch the ball beyond the net, provided that he/she does not interfere with the opponent's play before or during the latter's attack-hit.
- 11.1.2 After an attack-hit, a player is permitted to pass his/her hand beyond the net, provided that the contact has been made within his/her own playing space.

14.1,
14.3

11.2 PENETRATION INTO THE OPPONENT'S SPACE, COURT AND/OR FREE ZONE

- 11.2.1 A player may enter into the opponent's space, court and/or free zone, provided that this does not interfere with the opponent's play.

USAV 11.2: When competition is scheduled or is occurring on adjacent court(s), it is a fault for a player to enter the adjacent court(s), to play a ball or after playing a ball. The free zone, including the service zone on an adjacent court, is a playing area.

11.3 CONTACT WITH THE NET

- 11.3.1 Contact with the net by a player between the antennae, during the action of playing the ball, is a fault. The action of playing the ball includes (among others) take-off, hit (or attempt) and landing. 11.4.3, 22.3.2.3.c, 24.3.2.2, D3
- 11.3.2 Players may touch the post, ropes, or any other object outside the antennae, including the net itself, provided that it does not interfere with play.
- 11.3.3 When the ball is driven into the net, causing it to touch an opponent, no fault is committed.

11.4 PLAYER'S FAULTS AT THE NET

- 11.4.1 A player touches the ball or an opponent in the opponent's space before or during the opponent's attack-hit. D9(20)
- 11.4.2 A player interferes with the opponent's play while penetrating into the opponent's space under the net.
- 11.4.3 A player interferes with the opponent's play by (amongst others): 11.3.1, D3
-touching the net between the antennae or the antenna itself during his/her action of playing the ball,
-using the net between the antennae as a support or stabilizing aid,
-creating an unfair advantage over the opponent by touching the net,
-making actions which hinder an opponent's legitimate attempt to play the ball,
-catching/holding on to the net.
Players close to the ball as it is played, or who are trying to play it, are considered in the action of playing the ball, even if no contact is made with the ball. However, touching the net outside the antenna is not to be considered a fault (except for Rule 9.1.3).

12. SERVICE

The service is the act of putting the ball into play by the correct serving player placed in the service zone.

12.1 FIRST SERVICE IN A SET

- 12.1.1 The first service of a set is executed by the team determined by the toss. 6.3.2, 7.1

12.2 SERVICE ORDER

- 12.2.1 The players must follow the service order recorded on the score sheet.

- 12.2.2 After the first service in a set, the player to serve is determined as follows:
 - 12.2.2.1 when the serving team wins the rally, the player who served before serves again;
 - 12.2.2.2 when the receiving team wins the rally, it gains the right to serve and the player who did not serve last time will serve.

12.3 AUTHORIZATION OF THE SERVICE

The 1st referee authorizes the service, after having checked that the teams are ready to play and that the server is in possession of the ball. D9(1)

12.4 EXECUTION OF THE SERVICE

- 12.4.1 The ball shall be hit with one hand or any part of the arm after being tossed or released from the hand(s). D9(10)
- 12.4.2 Only one toss or release of the ball is allowed. Dribbling or moving the ball in the hands is permitted.
- 12.4.3 The server may move freely within the service zone. At the moment of the service hit or take-off for a jump service, the server must not touch the court (the end line included) or the ground outside the service zone. His/her foot may not go under the end line. D9(22), D10(4)

After the hit, he/she may step or land outside the service zone, or inside the court. If the line moves because of the sand pushed by the server, it is not considered a fault.
- 12.4.4 The server must hit the ball within 5 seconds after the 1st referee whistles for service. D9(11)
- 12.4.5 A service executed before the referee's whistle is cancelled and repeated. D9(23)
- 12.4.6 If the ball, after having been tossed or released by the server, lands without being touched or caught by the server, it is considered as a service.
- 12.4.7 No further service attempt will be permitted.

12.5 SCREENING

- 12.5.1 A player of the serving team must not prevent the opponent, through individual screening, from seeing the server and the flight path of the ball. D9(12) D5
- 12.5.2 A player of the serving team makes a screen by waving arms, jumping or moving sideways during the execution of the service to hide the server and D5

the flight path of the ball.

USAV Commentary: Screens will only be whistled when in the referee's judgment, the receiving player was prevented from seeing BOTH the server AND the flight of the ball.

12.6 FAULTS MADE DURING THE SERVICE

- 12.6.1 Serving faults
The following faults lead to a change of service.
The server:
 - 12.6.1.1 violates the service order; 12.2, D9(13)
 - 12.6.1.2 does not execute the service properly. 12.4
- 12.6.2 Faults after the service hit
After the ball has been correctly hit, the service becomes a fault if the ball:
 - 12.6.2.1 touches a player of the serving team or fails to cross the vertical plane of the net completely through the crossing space; D9(19)
 - 12.6.2.2 goes "out"; 8.4, D9(15)
 - 12.6.2.3 passes over a screen. D5

13. ATTACK-HIT

13.1 CHARACTERISTICS OF THE ATTACK-HIT

- 13.1.1 All actions which direct the ball toward the opponents, with the exception of service and block, are considered as attack-hits.
- 13.1.2 An attack-hit is completed the moment the ball completely crosses the vertical plane of the net or is touched by an opponent.
- 13.1.3 Any player may carry out an attack-hit at any height, provided that his/her contact with the ball has been made within the player's own playing space (except Rule 13.2.3, 13.2.5 below). 13.2.4, 13.2.5

13.2 FAULTS OF THE ATTACK-HIT

- 13.2.1 A player hits the ball within the playing space of the opposing team. 13.1.2, D9(20)
- 13.2.2 A player hits the ball "out." 8.4, D9(15)
- 13.2.3 A player completes an attack-hit using an open-handed finger action or if using fingertips that are not rigid and together. D9(21)

- 13.2.4 A player completes an attack-hit on the opponent's service, when the ball is entirely higher than the top of the net. D9(21)
- 13.2.5 A player completes an attack-hit using an overhand pass which has a trajectory not perpendicular to the line of the shoulders. The exception is when the player is attempting to set to his or her own teammate. D9(21)

14. BLOCK

14.1 BLOCKING

- 14.1.1 Blocking is the action of players close to the net to intercept the ball coming from the opponent by reaching higher than the top of the net, regardless of the height of the ball contact. At the moment of contact with the ball, a part of the body must be higher than the top of the net.
- 14.1.2 Block Attempt
A block attempt is the action of blocking without touching the ball.
- 14.1.3 Completed Block
A block is completed whenever the ball is touched by a blocker. D6
- 14.1.4 Collective Block
A collective block is executed by two or three players close to each other and is completed when one of them touches the ball.

14.2 BLOCK CONTACT

Consecutive (quick and continuous) contacts may occur by one or more blockers, provided that the contacts are made during one action. These are counted as only one team hit. These contacts may occur with any part of the body. 9.1.1, 9.2.3

14.3 BLOCKING WITHIN THE OPPONENT'S SPACE

In blocking, the player may place his/her hands and arms beyond the net provided that this action does not interfere with the opponent's play. Thus, it is not permitted to touch the ball beyond the net until an opponent has executed an attack-hit. 13.1.1

14.4 BLOCK AND TEAM HITS

- 14.4.1 A blocking contact is counted as a team hit. The blocking team will have only two more hits after a blocking contact.

14.4.2 The first hit after the block may be executed by any player, including the one who has touched the ball during the block.

14.5 BLOCKING THE SERVICE

To block an opponent's service is forbidden.

D9(12)

14.6 BLOCKING FAULTS

14.6.1 The blocker touches the ball in the OPPONENT'S space either before or simultaneously with the opponent's attack-hit.

14.3,
D9(20)

14.6.2 Blocking the ball in the opponent's space from outside the antenna.

14.6.3 A player blocks the opponent's service.

D9(12)

14.6.4 The ball is sent "out" off the block.

D9(24)

CHAPTER 5

INTERRUPTIONS, DELAYS AND INTERVALS

See Rules

15. INTERRUPTIONS

An interruption is the time between one completed rally and the 1st referee's whistle for the next service. The only regular game interruptions are TIME-OUTS.

D9(4)

15.1 NUMBER OF REGULAR GAME INTERRUPTIONS

Each team may request a maximum of one time-out per set.

15.2 SEQUENCE OF REGULAR GAME INTERRUPTIONS

15.2.1 Request for time-out by both teams may follow one another, within the same interruption.

15.2.2 There are no substitutions.

15.3 REQUEST FOR REGULAR GAME INTERRUPTIONS

Regular game interruptions may be requested only by the captain.

15.4 TIME-OUTS AND TECHNICAL TIME-OUTS

15.4.1 Time-out requests must be made by showing the corresponding hand signal, when the ball is out of play and before the whistle for service. All requested time-outs last for 30 seconds.

D9(4)

15.4.2 **For FIVB World and Official Competitions in sets 1 and 2, one additional 30-second "Technical Time-Out" is applied automatically when the sum of the points scored by the teams equals 21 points.**

15.4.3 In the deciding (3rd) set, there are no "Technical Time-Outs"; only one time-out of 30 seconds duration may be requested by each team.

15.4.4 During all regular interruptions and set intervals, players must go to the designated players' area.

15.5 IMPROPER REQUESTS

Among others, it is improper to request a time-out:

15.5.1 during a rally or at the moment of, or after the whistle to serve;

6.1.3

15.5.2 by a non-authorized team member;

15.5.3 after having exhausted the authorized time-outs.

15.1

15.5.4 Any improper request that does not affect or delay the game shall be rejected without any sanction un-

15.5,

16.1

- less repeated in the same match.
- 15.5.5 Any further improper request in the same match by the same team constitutes a delay. D9(25)

16. GAME DELAYS

16.1 TYPES OF DELAYS

An improper action of a team that defers resumption of the game is a delay and includes, among others:

- 16.1.1 prolonging time-outs, after having been instructed to resume the game;
- 16.1.2 repeating an improper request; 15.5
- 16.1.3 delaying the game (12 seconds shall be the maximum time from the end of a rally to the whistle for service under normal playing conditions);
- 16.1.4 delaying the game by a team member.

16.2 DELAY SANCTIONS

- 16.2.1 “Delay warning” and “delay penalty” are team sanctions.
- 16.2.1.1 Delay sanctions remain in force for the entire match.
- 16.2.1.2 All delay sanctions are recorded on the score sheet.
- 16.2.2 The first delay in the match by a team member is sanctioned with a “DELAY WARNING.” D9(25), D7b
- 16.2.3 The second and subsequent delays of any type by any member of the same team in the same match constitute a fault and are sanctioned with a “DELAY PENALTY”: a point and service to the opponent. D9(25), D7b
- 16.2.4 Delay sanctions imposed before or between sets are applied in the following set.

17. EXCEPTIONAL GAME INTERRUPTIONS

17.1 INJURY/ILLNESS

- 17.1.1 Should a serious accident occur while the ball is in play, the referee must stop the game immediately and permit medical assistance to enter the court.
- 17.1.2 An injured/ill player is given a maximum of 5 minutes recovery time, one time in a match. The referee must authorize the properly accredited medical staff to enter the playing court to attend the player. Only the 1st referee may authorize a player to leave the playing area without penalty. When the treatment has been completed or if no treatment can be pro-

vided, play must resume. The 2nd referee will whistle and request the player to continue. At this time, only the player can judge whether he/she is fit to play.

If the player does not recover or return to the playing area at the conclusion of the recovery time, his/her team is declared incomplete.

In extreme cases, the doctor of the competition can oppose the return of an injured player.

Note: The recovery time will begin when the properly accredited medical staff member(s) of the competition arrives at the playing court to attend to the player. In the event that no accredited medical staff is available or in cases where the player chooses to be treated by his/her own medical personnel, the time will begin from the moment the recovery time was authorized by the referee.

6.4.3,
7.3.1

17.2 EXTERNAL INTERFERENCE

If there is any external interference during the game, the play has to be stopped and the rally is replayed.

USAV 17.2: The referees, TV staff and auxiliary officials within the free zone in their normal working positions are considered as part of the court. They shall not be considered the cause of external interference unless they initiate the contact (or threat of contact) with the player and/or the ball. Spectators are not a part of the court; therefore, if they hinder a legitimate attempt to play the ball, a replay should be granted. For courts that do not have a clearly defined free-zone, the referees should identify the playing area during the pre-match captains' meeting.

17.3 PROLONGED INTERRUPTIONS

17.3.1 If unforeseen circumstances interrupt the match, the 1st referee, the organizer and the Control Committee, if there is one, shall decide the measures to be taken to re-establish normal conditions.

17.3.2 Should one or several interruptions occur, not exceeding 4 hours in total, the match is resumed with the score acquired, regardless of whether it continues on the same court or another court.

17.3.3 Should one or several interruptions occur, exceeding 4 hours in total, the whole match shall be replayed.

18. INTERVALS AND CHANGE OF COURTS/SWITCHES

18.1 INTERVALS

An interval is the time between sets. All intervals last 1 minute. During this period of time, the change of courts (if requested) and service order of the teams on the score sheet are made. During the interval before a deciding set the referees carry out a toss in accordance with Rule 7.1.

D9(3)

18.2 COURT SWITCHES

18.2.1 The teams switch after every 7 points (Set 1 and 2) and 5 points (Set 3) played.

D9(3)

18.2.2 During court switches the teams must change immediately without delay. If the court switch is not made at the proper time, it will take place as soon as the error is noticed. The score at the time that the court switch is made remains the same.

CHAPTER 6

PARTICIPANTS' CONDUCT

See
Rules

19. REQUIREMENTS OF CONDUCT

19.1 SPORTSMANLIKE CONDUCT

- 19.1.1 Participants must know the "Official Beach Volleyball Rules" and abide by them.
- 19.1.2 Participants must accept referees' decisions with sportsmanlike conduct, without disputing them. In case of doubt, clarification may be requested only through the game captain. 5.1.2.1
- 19.1.3 Participants must refrain from actions or attitudes aimed at influencing the decisions of the referees or covering up faults committed by their team.

19.2 FAIR PLAY

- 19.2.1 Participants must behave respectfully and courteously in the spirit of FAIR PLAY, not only toward the referees, but also toward other officials, the opponents, teammates and spectators.
- 19.2.2 Communication between team members during the match is permitted. 5.2.3.4

20. MISCONDUCT AND ITS SANCTIONS

USAV 20: Please refer to FIVB Diagrams 7a and 7b and USAV Diagram 7c on page B-46. This includes Misconduct Symbols and Sanctions for coaches.

20.1 MINOR MISCONDUCT

Minor misconduct offenses are not subject to sanctions. It is the 1st referee's duty to prevent the teams from approaching the sanctioning level. This is done in two stages: Stage 1: by issuing a verbal warning through the captain; Stage 2: by use of a YELLOW CARD to a team member. This formal warning is not in itself a sanction but a symbol that the team member (and by extension the team) has reached the sanctioning level for the match. It is recorded in the score sheet but has no immediate consequences. 5.1.2, 21.3

USAV 20:1: ...the team has reached a sanctioning level for the set. EXCEPTION for coaches is for the match. D9(5)

20.2 MISCONDUCT LEADING TO SANCTIONS

Incorrect conduct by a team member toward officials, op- 4.1.1

ponents, teammates or spectators is classified in three categories according to the seriousness of the offense.

- 20.2.1 Rude conduct: action contrary to good manners or moral principles.
- 20.2.2 Offensive conduct: defamatory or insulting words or gestures or any action expressing contempt.
- 20.2.3 Aggression: actual physical attack or aggressive or threatening behavior.

20.3 SANCTION SCALE

According to the judgment of the 1st referee and depending on the seriousness of the offense, the sanctions to be applied and recorded on the score sheet are: Penalty, Expulsion or Disqualification. D7a

- 20.3.1 Penalty
For rude conduct or a single repetition of rude conduct in the same set by the same player. On each of the first two occasions, the team is sanctioned with a point and service to the opponents. A third rude conduct by a player in the same set is sanctioned by expulsion. Rude conduct sanctions may, however, be given to the same player in subsequent sets. D9(6)
- 20.3.2 Expulsion
The first offensive conduct is sanctioned by expulsion. The player who is sanctioned must leave the playing area and his/her team is declared incomplete for the match. 6.4.3, 7.3.1, D9(7)
- 20.3.3 Disqualification
The first physical attack or implied or threatened aggression is sanctioned by disqualification. The player must leave the playing area and his/her team is declared incomplete for the match. 6.4.3, 7.3.1, D9(8)
MISCONDUCT is sanctioned as shown in the sanction scale. D7a

20.4 MISCONDUCT BEFORE AND BETWEEN SETS

Any misconduct occurring before or between sets is sanctioned according to the sanction scale and the sanction is applied in the following set. D7a

20.5 SUMMARY OF MISCONDUCT AND CARDS USED	D9 (5, 6, 7, 8)
Warning: no sanction – Stage 1: verbal warning Stage 2: symbol Yellow card	20.1
Penalty: sanction – symbol Red card	20.3.1, D7a
Expulsion: sanction – symbol Red + Yellow cards jointly	20.3.2, D7a
Disqualification: sanction – symbol Red + Yellow card separately	20.3.3, D7a

PART 2, SECTION 2:

THE REFEREES, THEIR RESPONSIBILITIES AND OFFICIAL HAND SIGNALS OFFICIAL BEACH VOLLEYBALL RULES 2015-2017

CHAPTER 7

REFEREES

See
Rules

21. REFEREEING CORPS AND PROCEDURES

21.1 COMPOSITION

The refereeing corps for a match is composed of the following officials:

- the 1st referee,
- the 2nd referee,
- the scorer,
- four (two) line judges.

Their location is shown in Diagram 8.

For FIVB World and Official Competitions, an assistant scorer is compulsory.

21.2 PROCEDURES

- 21.2.1 Only the 1st and 2nd referees may blow a whistle during the match:
- 21.2.1.1 the 1st referee gives the signal for the service that begins the rally; D9(1)
 - 21.2.1.2 the 1st and 2nd referees signal the end of the rally, provided that they are sure that a fault has been committed and they have identified its nature.
- 21.2.2 They may blow the whistle when the ball is out of play to indicate that they authorize or reject a team request.
- 21.2.3 Immediately after the referee's whistle to signal **the completion** of the rally, they have to indicate with the official hand signals: 22.2.1.2 28.1
- 21.2.3.1 If the fault is whistled by the 1st referee, he/she will indicate in order: D9(2)
 - a) the team to serve,
 - b) the nature of the fault,
 - c) the player(s) at fault (if necessary).
- USAV 21.2.3.1: The 2nd referee will follow the 1st referee's hand signals by repeating them.
- 21.2.3.2 If the fault is whistled by the 2nd referee,

he/she will indicate:
a) the nature of the fault,
b) the player at fault (if necessary),
c) the team to serve following the hand signal of the 1st referee. D9(2)

In this case, the 1st referee does not show **either the nature of the fault or the player at fault, but only the team to serve.**

21.2.3.3 In the case of a double fault both referees indicate in order: D9(23)

a) the nature of the fault,
b) the players at fault (if necessary).
The team to serve next is then indicated by the 1st referee. D9(2)

22. 1ST REFEREE

22.1 LOCATION

The 1st referee carries out his/her functions standing on a referee's stand located at one end of the net on the opposite side to the scorer. His/her view must be approximately 50 cm (19^{1/2}") above the net. D1, D8

22.2 AUTHORITY

22.2.1 The 1st referee directs the match from the start until the end. He/she has authority over all members of the refereeing corps and the members of the teams. During the match his/her decisions are final. He/she is authorized to overrule the decisions of other members of the refereeing corps, if it is noticed that they are mistaken.

The 1st referee may even replace a member of the refereeing corps who is not performing his/her functions properly.

22.2.2 He/she also controls the work of the ball retrievers.

22.2.3 He/she has the power to decide any matter involving the game, including those not provided for in the Rules.

22.2.4 He/she shall not permit any discussion about his/her decisions.

However, at the request of the game captain, the 1st referee will give an explanation on the application or interpretation of the Rules upon which he/she has based his/her decision.

If the captain disagrees with the explanation and formally protests, the 1st referee must authorize the commencement of a Protest Protocol.

22.2.5 The 1st referee is responsible for determining before and during the match whether the playing area and the conditions meet playing requirements.

22.3 RESPONSIBILITIES

22.3.1 Prior to the match, the 1st referee:

22.3.1.1 inspects the conditions of the playing area, the balls and other equipment;

22.3.1.2 performs the toss with the team captains;

22.3.1.3 controls the teams warming-up.

22.3.2 During the match, he/she is authorized:

22.3.2.1 to issue warnings to the teams;

22.3.2.2 to sanction misconduct and delays;

22.3.2.3 to decide upon:

a) the faults of the server and the screen of the serving team;

b) the faults in playing the ball;

c) the faults above the net, and the faulty contact of the player with the net, primarily on the attacker's side;

d) the ball crossing completely the lower space under the net.

USAV 22.3.2.3e: For Six-Player Competition only: position faults by the serving team.

22.3.3 At the end of the match, he/she checks the score sheet and signs it.

D5

D9(22)

23. 2nd REFEREE

23.1 LOCATION

The 2nd referee performs his/her functions standing outside the playing court near the post, on the opposite side of and facing the 1st referee.

D1, D8

23.2 AUTHORITY

23.2.1 The 2nd referee is the assistant of the 1st referee, but has also his/her own range of jurisdiction.

Should the 1st referee become unable to continue his/her work, the 2nd referee may replace him/her.

23.2.2 He/she may, without whistling, also signal faults outside his/her range of jurisdiction, but may not insist on them to the 1st referee.

23.3

- 23.2.3 He/she controls the work of the scorer(s).
- 23.2.4 He/she reports any misconduct to the 1st referee. D9(3,4)
- 23.2.5 He/she authorizes the time-outs and court switches, controls the duration of such and rejects improper requests.
- 23.2.6 He/she checks the number of time-outs used by each team and reports to the 1st referee and the players concerned after completion of their time-out.
- 23.2.7 In the case of an injury of a player, the 2nd referee authorizes and assists in managing the recovery time. 17.1.2
- 23.2.8 He/she checks during the match that the balls still meet the requirements of the regulations.
- 23.2.9 He/she conducts the toss between sets 2 and 3, if applicable. He/she then must pass all relevant information to the scorer.

23.3 RESPONSIBILITIES

- 23.3.1 At the start of each set, and whenever necessary, the 2nd controls the work of the scorer and checks that the correct server has the ball.
- 23.3.2 During the match, the 2nd referee decides, whistles and signals:
 - 23.3.2.1 interference due to penetration into the opponent's court and the space under the net; 11.2, D9(22)
 - 23.3.2.2 the faulty contact of the player with the net primarily on the blocker's side and with the antenna on his/her side of the court, 11.3.1
 - 23.3.2.3 the contact of the ball with an outside object; 8.4.2, 8.4.3, D9(15), D10(4)
 - 23.3.2.4 the ball that crosses the net totally or partly outside the crossing space to the opponent court or touches the antenna on his/her side of the court, including during service; 8.4.3, 8.4.4, D3, D4a, D9(15)
 - 23.3.2.5 the contact of the ball with the sand when the 1st referee is not in position to see the contact;
 - 23.3.2.6 the ball recovered completely on the opponent's side under the net. D9(22)
 - 23.3.2.7 USAV 23.3.2.7: For Six-Player Competition only: Position faults on receiving team and attack line violations.
- 23.3.3 At the end of the match, he/she checks and signs the score sheet.

24. SCORER

24.1 LOCATION

The scorer performs his/her functions seated at the scorer's table on the opposite side of the court from and facing the 1st referee. D1, D8

24.2 RESPONSIBILITIES

The scorer fills in the score sheet according to the rules, cooperating with the 2nd referee.

He/she uses a buzzer or other sound device to notify irregularities or give signals to the referees on the basis of his/her responsibilities.

24.2.1 Prior to the match and set, the scorer:

24.2.1.1 registers the data of the match and teams, according to the procedures in force and obtains the signatures of the captains and the coaches;

24.2.1.2 records the service order of each team.

24.2.2 During the match, the scorer:

24.2.2.1 records the points scored;

USAV 24.2.2.2.1: For Triples Four-Player and Six-Player Competition only: monitors the serving order of each team, indicating any error in rotation to the referees immediately after the service contact.

24.2.2.2 controls the serving order of each team and indicates any error before the service hit;

24.2.2.3 records the time-outs, checking the number of such, and informs the 2nd referee

24.2.2.4 notifies the referees of a request for time-out that is improper; 15.5

24.2.2.5 announces to the referees the court switches and the end of the sets;

24.2.2.6 records any sanctions and improper requests;

24.2.2.7 records all other events as instructed by the 2nd referee, i.e. recovery time, prolonged interruptions, external interference, re-designation, etc.

24.2.2.8 controls the interval between sets.

24.2.3 At the end of the match, the scorer:

24.2.3.1 records the final result;

- 24.2.3.2 in the case of protest, with the previous authorization of the 1st referee, writes or permits the captain concerned to write on the score sheet a statement on the incident being protested;
 - 24.2.3.3 signs the score sheet, before he/she obtains the signatures of the team captains and then the referees.
- USAV 24.2.3.3: In USAV play, the captains' post-set signature is not required. (See USAV 5.1.3.1.)

5.1.2.1,
5.1.3.2

25. ASSISTANT SCORER

25.1 LOCATION

D1, D8

The assistant scorer performs his/her functions seated beside the scorer at the scorer's table.

25.2 RESPONSIBILITIES

He/she assists with the administrative duties of the scorer's work. Should the scorer become unable to continue his/her work, the assistant scorer substitutes for the scorer.

- 25.2.1 Prior to the match and set, the assistant scorer:
 - 25.2.1.1 checks that all information displayed at the scoreboard(s) is correct.
- 25.2.2 During the match, the assistant scorer:
 - 25.2.2.1 indicates the serving order of each team by displaying a sign numbered 1 or 2 corresponding to the player to serve and,
 - 25.2.2.2 indicates by use of the buzzer any error to the referees immediately;
 - 25.2.2.3 operates the manual scoreboard on the scorer's table;
 - 25.2.2.4 checks that the scoreboards agree;
 - 25.2.2.5 starts and ends the timing of the Technical Time-Outs;
 - 25.2.2.6 if necessary, updates the reserve score sheet and gives it to the scorer.
- 25.2.3 At the end of the match, the assistant scorer:
 - 25.2.3.1 signs the score sheet.

26. LINE JUDGES

26.1 LOCATION

If only two line judges are used, they stand at the corners of the court closest to the right hand of each referee, diagonally at 1 to 2 m (39" to 6'6^{3/4}") from the corner. Each one of them controls both the end line and side line on his/her side.

For FIVB World and Official Competitions, when it is compulsory to have four line judges, they stand in the free zone at 1 to 3 m (39" to 9'10") from each corner of the court, on the imaginary extension of the line that they control.

D1, D8

26.2 RESPONSIBILITIES

- | | | |
|----------|---|-----------------------------------|
| 26.2.1 | The line judges perform their functions by using flags (40 X 40 cm) (16" X 16") to signal: | D10 |
| 26.2.1.1 | the ball "in" and "out" whenever the ball lands near their line(s). (Note: It is primarily the line judge closest to the path of the ball who is responsible for the signal); | 8.3, 8.4, D10(1,2) |
| 26.2.1.2 | the touches of "out" balls by the team receiving the ball; | 8.4, D10(3) |
| 26.2.1.3 | the ball touching the antenna, the served ball and the third hit of the team crossing the net outside the crossing space, etc.; | 8.4.3, 8.4.4, 10.1.1, D4a, D10(4) |
| 26.2.1.4 | any player (except the server) stepping outside of his/her court at the moment of the service hit; | 7.4, 12.4.3, D10(4) |
| 26.2.1.5 | the foot faults of the server; | 12.4.3, D10(4) |
| 26.2.1.6 | any contact with the top 80 cm (32") of the antenna on their side of the court by any player during his/her action of playing the ball or interfering with the play; | 11.3.1, 11.4.4, D3, D10(4) |
| 26.2.1.7 | the ball crossing the net outside the crossing space into opponent's court or touching the antenna on his/her side of the court; | 10.1.1, D4a, D10(4) |
| 26.2.1.8 | the block touches during the rally. | |
| 26.2.2 | At the 1 st referee's request, a line judge must repeat his/her signal. | |

27. OFFICIAL SIGNALS

27.1 REFEREES' HAND SIGNALS

The referees will indicate with the official hand signal the reason for their whistle (nature of the fault whistled or the purpose of the interruption authorized). The signal has to be maintained for a moment and, if it is indicated with one hand, the hand corresponds to the side of the team which has made the fault or the request.

D9

27.2 LINE JUDGES' FLAG SIGNALS

The line judges must indicate with the official flag signal the nature of the fault called, and maintain the signal for a moment.

D10

DIAGRAM 1: THE PLAYING AREA

Relevant Rules: 1, 22.1, 23.1, 24.1, 25.1, 26.1

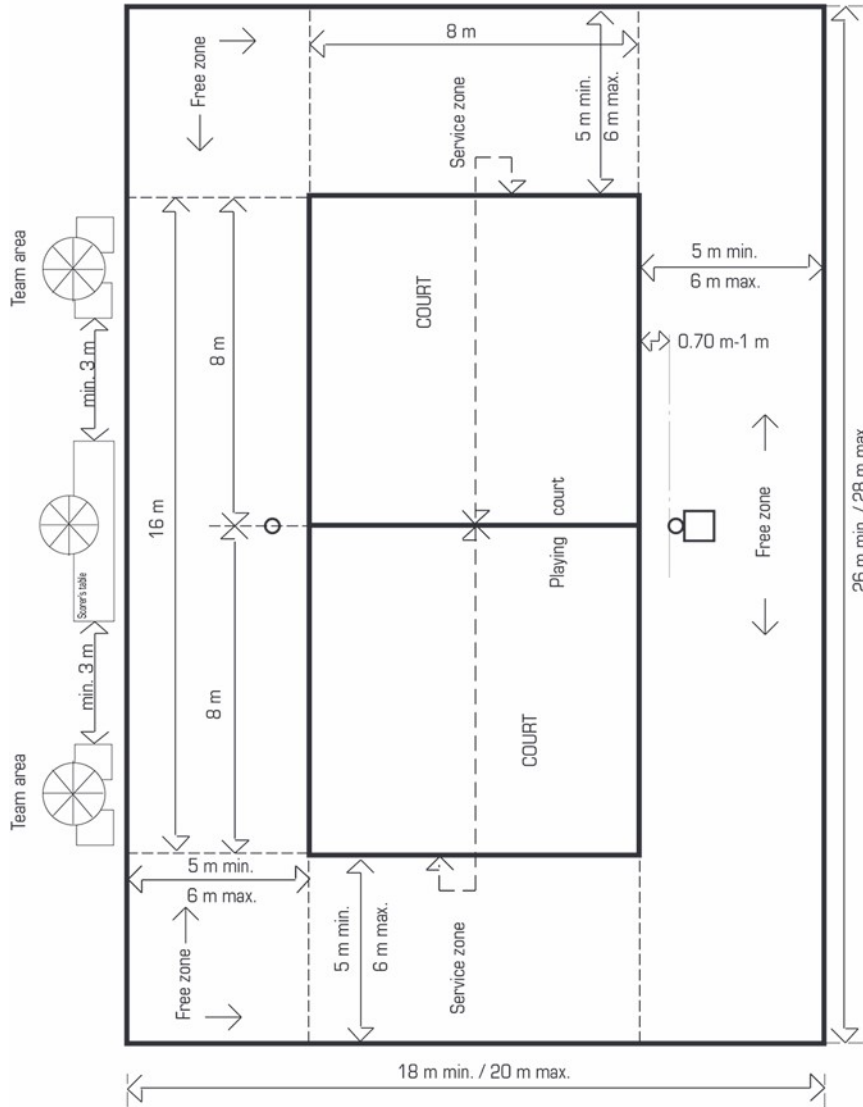
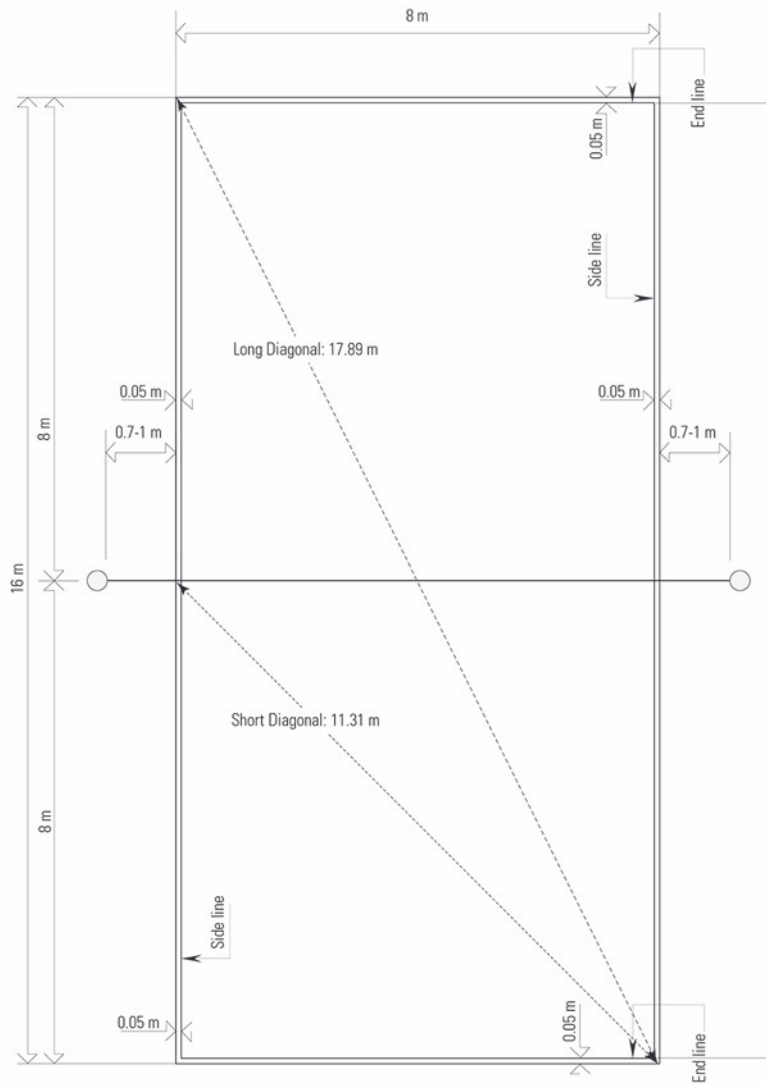

DIAGRAM 2: THE PLAYING COURT

Relevant Rules: 1.1, 1.3, 2.5



OFFICIAL BEACH VOLLEYBALL RULES 2013-2016

DIAGRAM 3: DESIGN OF THE NET

Relevant Rules: 2, 8.4.3

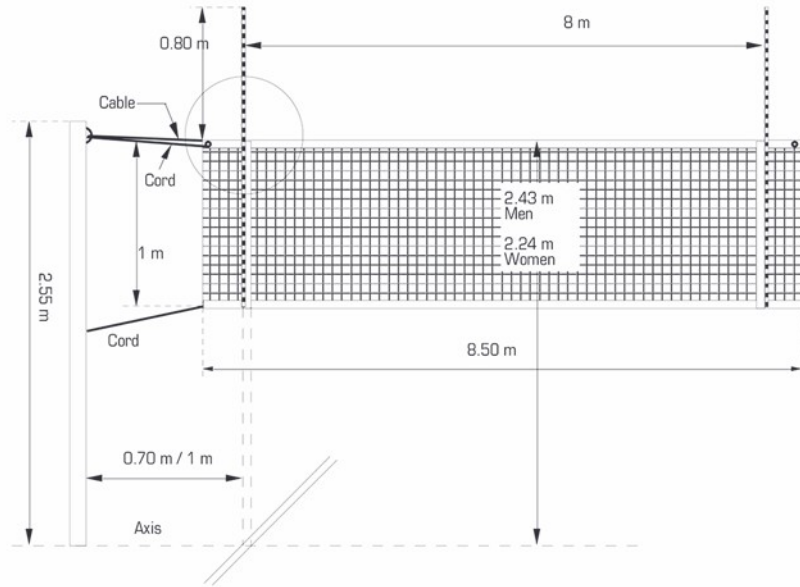

For FIVB, World and Official Competitions, the net may be adjusted according 2.1 above.

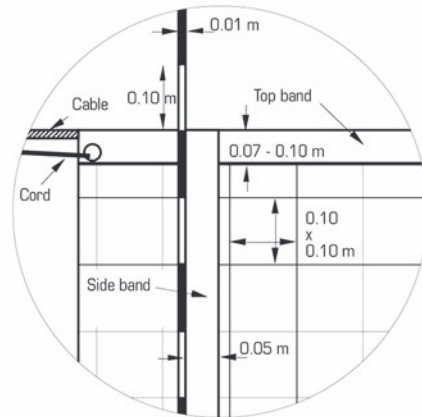
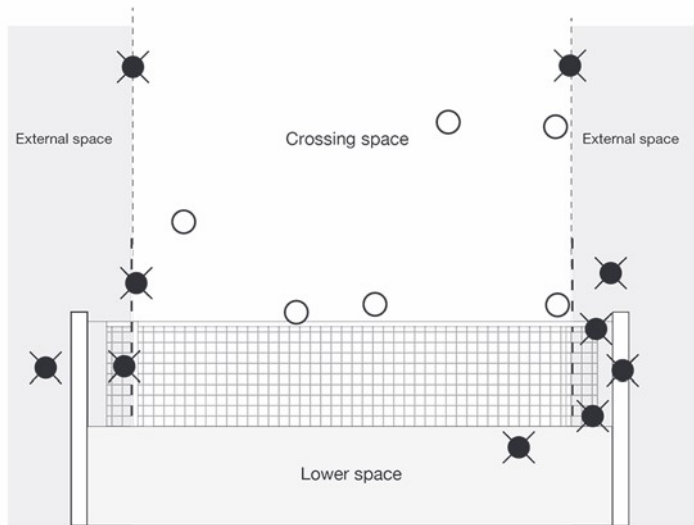

DIAGRAM 4a: BALL CROSSING THE VERTICAL PLANE OF THE NET TO THE OPPONENT COURT

Relevant Rules: 8.4.3, 8.4.4, 8.4.5, 10.1.1, 23.3.2.4, 26.2.1.3, 26.2.1.7



- = Fault
- = Correct crossing

DIAGRAM 4b: BALL CROSSING THE VERTICAL PLANE OF THE NET TO THE OPPONENT FREE ZONE

Relevant Rules: 10.1.2, 10.1.2.1

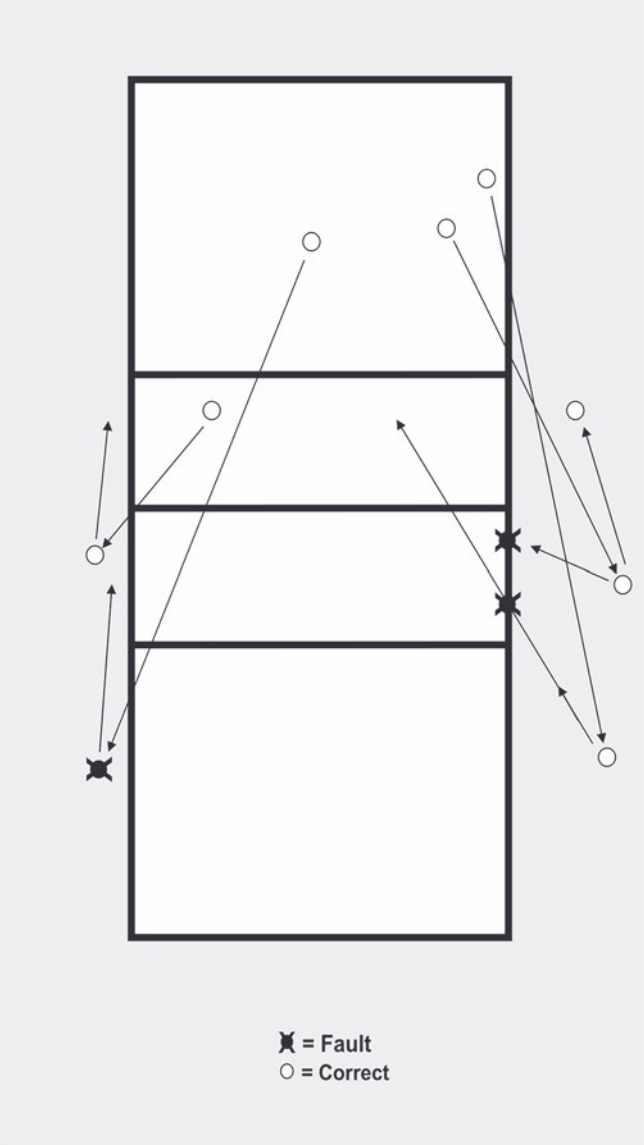

DIAGRAM 5: SCREEN

Relevant Rules: 12.5.1, 12.5.2, 12.6.2.3, 22.3.2.3

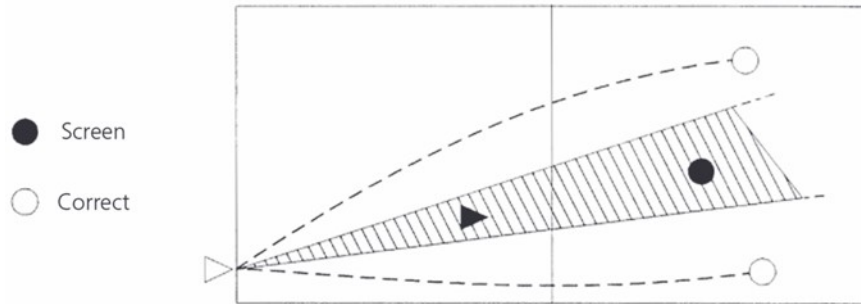
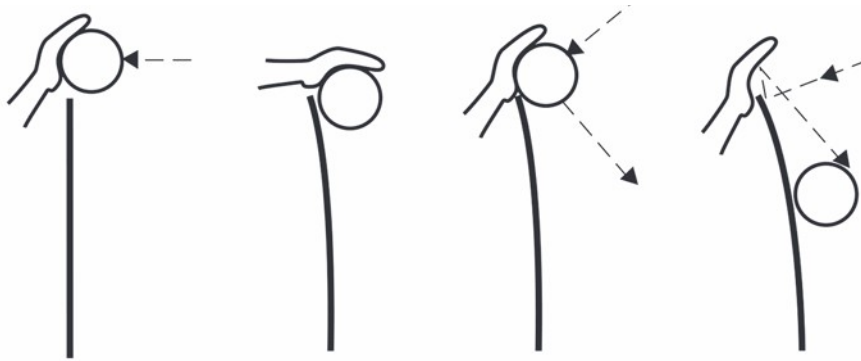

DIAGRAM 6: COMPLETED BLOCK

Relevant Rules: 14.1.3



Ball above the net

Ball lower than the top of the net

Ball touches the net

Ball bounces off the net

DIAGRAM 7: DETERRENTS AND SANCTIONS

Note: The application of the yellow card is not the sanction. Sanctions are shown in the table below.

DIAGRAM 7a: SANCTIONS SCALE AND CONSEQUENCES

Relevant Rules : 20.3, 20.4, 20.5

CATEGORIES	OCCURRENCE	OFFENDER	SANCTION	CARDS	CONSEQUENCE
RUDE CONDUCT (same set)	First	Any member	Penalty	Red	A point and service to the opponent
	Second	Same member	Penalty	Red	A point and service to the opponent
	Third	Same member	Expulsion	Red + Yellow jointly	Team declared incomplete for the set
RUDE CONDUCT (new set)	First	Any member	Penalty	Red	A point and service to the opponent
OFFENSIVE CONDUCT	First	Any member	Expulsion	Red + Yellow jointly	Team declared incomplete for the set
	Second	Same member	Disqualification	Red + Yellow separately	Team declared incomplete for the match
AGGRESSION	First	Any member	Disqualification	Red + Yellow separately	Team declared incomplete for the match

DIAGRAM 7b: DELAY SANCTIONS SCALE AND CONSEQUENCES

Relevant Rules : 16.2.2, 16.2.3

CATEGORIES	OCCURRENCE	OFFENDER	DETERRENT or SANCTION	CARDS	CONSEQUENCE
DELAY	First	Any member of the team	Delay Warning	Red signal with Yellow card	Prevention – no penalty
	Second and subsequent	Any member of the team	Delay Penalty	Red signal with Red card	A point and service to the opponent

DIAGRAM 7c: MISCONDUCT SANCTION SCALE (COACHES)

Relevant Rules : 20.3, 20.4, 20.5

CATEGORIES	OCCURRENCE	OFFENDER	DETERRENT OR SANCTION	CARDS TO SHOW	CONSEQUENCES
1. Unsportsmanlike conduct	1st per match	Any coach	Warning	Yellow	Prevention no penalty
	2nd per match	Same coach	Penalty	Red	A point & service to the opponent
2. Rude conduct	1st per match	Any coach	Penalty	Red	A point & service to the opponent
	2nd per match	Same coach	Expulsion	Red & Yellow together	Must leave the court & immediate vicinity for the set
3. Offensive conduct	1st	Any coach	Expulsion	Red & Yellow together	Must leave the court & immediate vicinity for the set
	2nd	Same coach	Disqualification	Red & Yellow separately	Must leave the competition site for the match
4. Aggression	1st	Any coach	Disqualification	Red & Yellow separately	Must leave the competition site for the match

DIAGRAM 8: LOCATION OF REFEREEING CORPS AND THEIR ASSISTANTS

Relevant Rules: 3.3, 21.1, 22.1, 23.1, 24.1, 25.1, 26.1

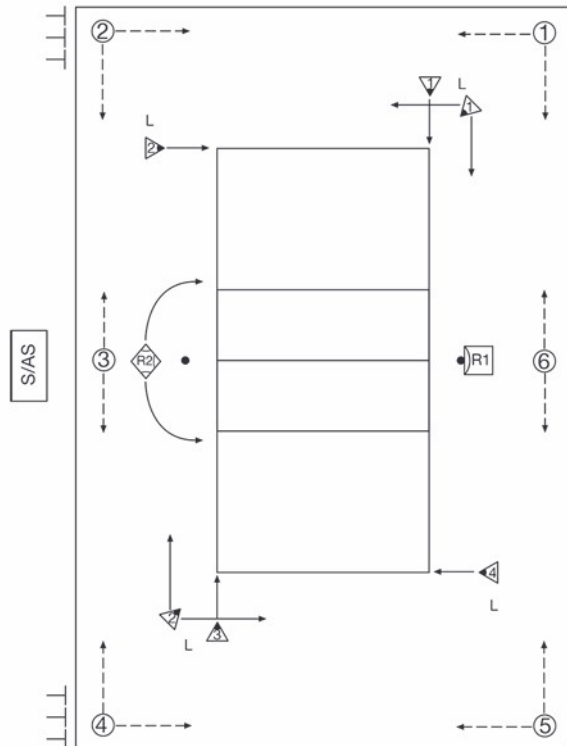

- R1 = First Referee
- ◆ R2 = Second Referee
- S/AS = Scorer/Assistant Scorer
- ▵ = Lines Judges (numbers 1-4 or 1-2)
- ④ = Ball Retrievers (numbers 1-6)
- ┌ = Sand Levelers

DIAGRAM 9: REFEREES' HAND SIGNALS

1. All signals which are made with one hand shall be made with the hand on the side of the team that commits the fault or makes the request.
2. After the signal is made, the referee gestures to the player who has committed the fault or the team that has made the request.

Authorization to Serve

Relevant Rules: 12.3, 12.2.1.1

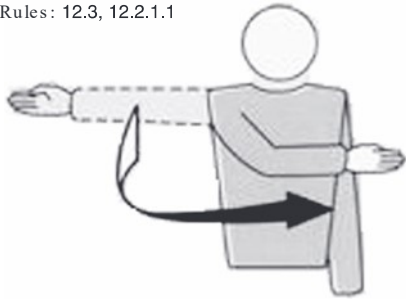

1

Move the hand to indicate the direction of service.

F			
---	--	--	--

Team to Serve

Relevant Rules:
12.3, 21.2.3.1a,
21.2.3.2c, 21.2.3.3c

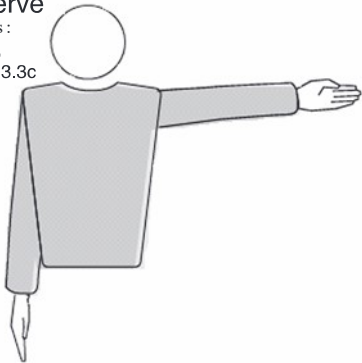

2

Extend the arm to the side of the team that will serve.

F	S		
---	---	--	--

Change of Courts

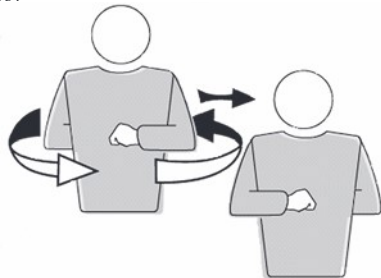

Relevant Rules:
18.2, 23.2.5







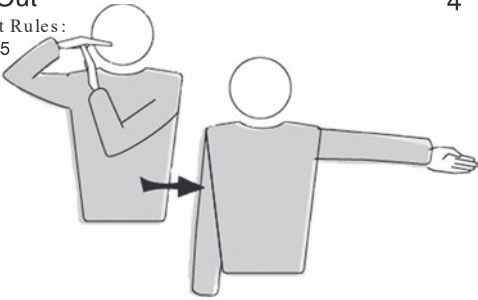
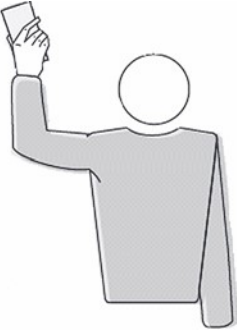

3

Raise the forearms front and back and twist them around the body.

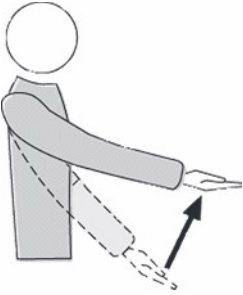

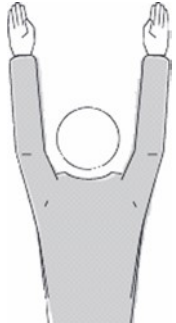

F			
---	--	--	--

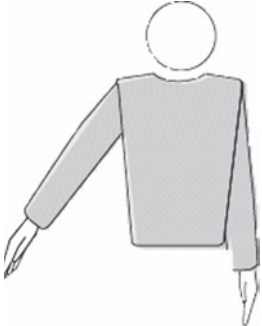
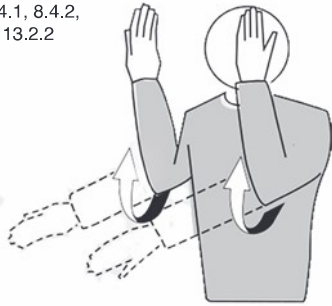
<p>Time-Out Relevant Rules: 15, 23.2.5</p> 	<p>4</p> <p>Place the palm of one hand over the fingers of the other, held vertically (forming a "T") and then indicate the requesting team.</p> <table border="1" data-bbox="695 399 976 456"> <tr> <td>F</td> <td>S</td> <td></td> <td></td> </tr> </table>	F	S		
F	S				
<p>Misconduct Warning Relevant Rules: 20.1, 20.5</p> 	<p>5</p> <p>Show a yellow card for warning.</p> <table border="1" data-bbox="695 756 976 821"> <tr> <td>F</td> <td></td> <td></td> <td></td> </tr> </table>	F			
F					
<p>Misconduct Penalty Relevant Rules: 20.3.1, 20.5</p> 	<p>6</p> <p>Show a red card for penalty.</p> <table border="1" data-bbox="695 1114 976 1179"> <tr> <td>F</td> <td></td> <td></td> <td></td> </tr> </table>	F			
F					
<p>Expulsion Relevant Rules: 20.3.2, 20.5</p> 	<p>7</p> <p>Show both cards jointly for expulsion.</p> <table border="1" data-bbox="695 1471 976 1533"> <tr> <td>F</td> <td></td> <td></td> <td></td> </tr> </table>	F			
F					

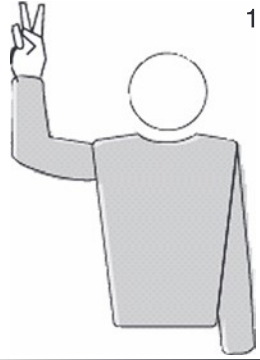
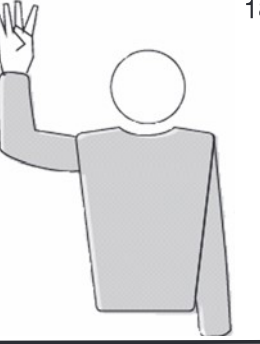
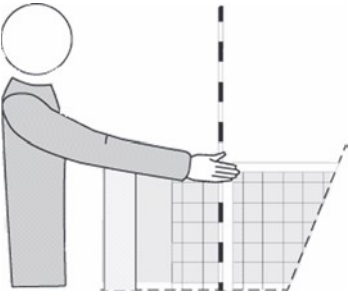
<p>Disqualification Relevant Rules : 20.3.3, 20.5</p> 	<p>8</p> <p>Show red and yellow cards separately for disqualification.</p>
<p>End of Set or Match Relevant Rules : 6.2, 6.3</p> 	<p>9</p> <p>Cross the forearms in front of the chest, hands open.</p>
<p>Ball Not Tossed or Released at the Service Hit Relevant Rule: 12.4.1</p> 	<p>10</p> <p>Lift the extended arm, the palm of the hand facing upwards.</p>
<p>Delay in Service Relevant Rule: 12.4.4</p> 	<p>11</p> <p>Raise five fingers, spread open.</p>

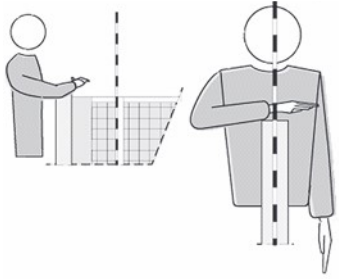
<p>Blocking Fault or Screening Relevant Rules: 12.5, 14.5, 14.6.3</p> 	<p>12</p> <p>Raise both arms vertically, palms forward.</p>
<p>Positional or Rotation Fault Relevant Rules: 7.7.1, 12.6.1.1</p> 	<p>13</p> <p>Make a circular motion with the forefinger.</p>
<p>Ball "In" Relevant Rules: 6.1.1.1, 8.3</p> 	<p>14</p> <p>Point the arm and the fingers toward the floor.</p>
<p>Ball "Out" Relevant Rules: 8.4.1, 8.4.2, 8.4.3, 8.4.4, 12.6.2, 13.2.2</p> 	<p>15</p> <p>Raise the forearms vertically, hands open, palms toward the body.</p>
<p>F S</p>	<p>F S</p>
<p>F S</p>	<p>F S</p>
<p>F S</p>	<p>F S</p>
<p>F S</p>	<p>F S</p>

<p>Catch Relevant Rules: 6.1.2, 9.3.3, 22.3.2.3b</p> 	<p>16</p> <p>Slowly lift the forearm, palm of the hand facing upwards.</p>																		
<p>Double Contact Relevant Rules: 6.1.2, 9.1.1, 9.3.4, 22.3.2.3b</p> 	<p>17</p> <p>Raise two fingers spread open.</p>																		
<p>Four Hits Relevant Rule: 9.3.1</p> 	<p>18</p> <p>Raise four fingers, spread open.</p>																		
<p>(1) Net Touched by Player (2) Served Ball Fails to Pass to the Opponent Through Crossing Space Relevant Rule: 12.6.2.1</p> 	<p>19</p> <p>Indicate the respective side of the net.</p>																		
<table border="1"> <tr> <td>F</td> <td></td> <td></td> <td></td> </tr> </table>	F				<table border="1"> <tr> <td>F</td> <td></td> <td></td> <td></td> </tr> </table>	F				<table border="1"> <tr> <td>F</td> <td></td> <td></td> <td></td> </tr> </table>	F				<table border="1"> <tr> <td>F</td> <td>S</td> <td></td> <td></td> </tr> </table>	F	S		
F																			
F																			
F																			
F	S																		

<p>Reaching Beyond the Net 20</p> <p>Relevant Rules: 11.4.1, 13.2.1</p> 	<p>Place a hand above the net, palm facing downwards.</p> <table border="1" data-bbox="688 396 972 456"> <tr> <td>F</td> <td></td> <td></td> <td></td> </tr> </table>	F			
F					
<p>Attack-Hit Fault 21</p> <p>-by a player who completes an attack-hit using an open-handed finger action, or if using fingertips that are not rigid and together. -by a player who completes an attack-hit on the opponent's service, when the ball is entirely higher than the top of the net. -by a player who completes an attack-hit using an overhand pass which has a trajectory not perpendicular to the line of the shoulders, except when he/she is attempting to set to his or her teammate.</p> <p>Relevant Rules: 13.2.3, 13.2.4, 13.2.5</p> 	<p>Make a downward motion with the forearm, hand open.</p> <table border="1" data-bbox="688 756 972 821"> <tr> <td>F</td> <td></td> <td></td> <td></td> </tr> </table>	F			
F					
<p>Interference due to penetration into the opponent's court and space under the net. 22</p> <p>Ball crosses completely the lower space under the net. The server touches the court (the end line included) or the ground outside the service zone. Unless for the server, the player steps outside his/her court at the moment of the service hit.</p> <p>Relevant Rules: 8.4.5, 11.2.1, 12.4.3, 23.3.2.1, 23.3.2.6</p> 	<p>Point to the center line or to the respective line.</p> <table border="1" data-bbox="688 1114 972 1175"> <tr> <td>F</td> <td>S</td> <td></td> <td></td> </tr> </table>	F	S		
F	S				
<p>Double Fault and Replay 23</p> <p>Relevant Rules: 6.1.2.2, 12.4.5</p> 	<p>Raise both thumbs vertically.</p> <table border="1" data-bbox="688 1468 972 1526"> <tr> <td>F</td> <td></td> <td></td> <td></td> </tr> </table>	F			
F					

Ball Touched
Relevant Rule: 14.6.4



24

Brush with the palm of one hand the fingers of the other, held vertically.

F			
---	--	--	--

Delay Warning/
Delay Penalty

Relevant Rules: 15.5.5, 16.2.2,
16.2.3

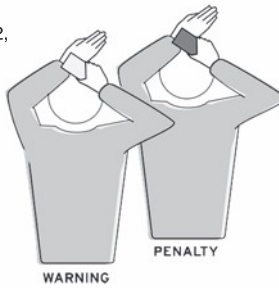



25

Cover the wrist with a yellow card (warning) and with a red card (penalty).

F			
---	--	--	--

**DIAGRAM 10: LINE JUDGES' OFFICIAL
FLAG SIGNALS**

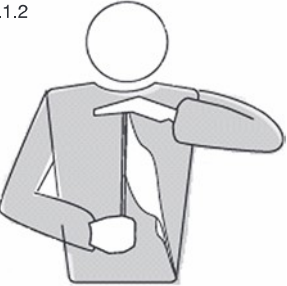
<p>Ball "In" Relevant Rules: 8.3, 26.2.1.1</p> 	1	<p>Point down with flag.</p>				
		<table border="1" style="width: 100%; height: 35px;"> <tr> <td style="width: 25%;"></td> <td style="width: 25%;"></td> <td style="width: 25%;"></td> <td style="width: 25%; text-align: center;">L</td> </tr> </table>				L
			L			
<p>Ball "Out" Relevant Rules: 8.4.1, 26.2.1.1</p> 	2	<p>Raise flag vertically.</p>				
		<table border="1" style="width: 100%; height: 35px;"> <tr> <td style="width: 25%;"></td> <td style="width: 25%;"></td> <td style="width: 25%;"></td> <td style="width: 25%; text-align: center;">L</td> </tr> </table>				L
			L			
<p>Ball Touched Relevant Rule: 26.2.1.2</p> 	3	<p>Raise flag and touch the top with the palm of the free hand.</p>				
		<table border="1" style="width: 100%; height: 35px;"> <tr> <td style="width: 25%;"></td> <td style="width: 25%;"></td> <td style="width: 25%;"></td> <td style="width: 25%; text-align: center;">L</td> </tr> </table>				L
			L			

<p>Crossing Space Faults, Ball Touched an Outside Object or Foot Fault by any Player During Service</p> <p>Relevant Rules: 8.4.2, 8.4., 8.4.4, 12.4.3, 26.2.1.3, 26.2.1.4, 26.2.1.5, 26.2.1.6, 26.2.1.7</p>	4	<p>Wave flag over the head and point to the antenna or the respective line.</p>
<p>Judgment Impossible</p>		<p>5</p> <p>Raise and cross both arms and hands in front of the chest.</p>



			L
--	--	--	---

F			
---	--	--	--

DEFINITIONS

COMPETITION/CONTROL AREA: The Competition/Control Area is a corridor around the playing court and free zone, which includes all spaces up to the outer barriers or delimitation fence. See diagram/fig 1a.

ZONES: These are sections within the playing area (i.e. playing court and free zone) as defined for a specific purpose (or with special restrictions) within the rule text. These include: Service Zone & Free Zone.

LOWER SPACE: This is the space defined as its upper part by the bottom of the net and the cord joining it to the posts, at the sides by the posts, and the bottom by the playing surface.

CROSSING SPACE: The crossing space is defined by:

- The horizontal band at the top of the net
- The antennae and their extension
- The ceiling

The ball must cross to the opponent's COURT through the crossing space.

EXTERNAL SPACE: The external space is in the vertical plane of the net outside of the crossing and lower spaces.

UNLESS BY AGREEMENT OF FIVB: This statement recognizes that while there are regulations on the standards and specification of equipment and facilities, there are occasions when special arrangements can be made by FIVB in order to promote the game of Beach Volleyball or to test new conditions.

FIVB STANDARDS: The technical specifications or limits as defined by FIVB to the manufacturers of equipment.

FAULT: a) A playing action contrary to the rules; b) a rule violation other than a playing action.

TECHNICAL TIME-OUT: This special mandatory time-out is, in addition to time-outs, to allow the promotion of Beach Volleyball, analysis of the play and to allow additional commercial opportunities. Technical Time-Outs are mandatory for FIVB, World and Official competitions.

BALL RETRIEVERS: These are personnel whose job it is to maintain the flow of the game by rolling the ball to the server between rallies.

RALLY POINT: This is the system of scoring a point whenever a rally is won.

INTERVAL: The time between sets. The change of courts in the fifth (deciding) set is not to be regarded as an interval.

INTERFERING: Any action which will create an advantage against the opponent team or any action which prevents an opponent from playing the ball.

OUTSIDE OBJECT: An object or a person which while outside the playing court or close to the limit of the free playing space provides an obstruction to the flight of the ball. For example: overhead lights, the referee's chair, TV equipment, scorer's table, and net posts. Outside objects do not include the antennae since they are considered as the part of the net.

SAND LEVELLERS (RAKERS): These court assistants use long rakes or long poles with flattened ends to smooth out the sand, especially around the court lines and across the central axis of the court between the posts.

**INSTRUCTIONS FOR USE OF THE
USA VOLLEYBALL OFFICIAL BEACH VOLLEYBALL
SCORE SHEETS**

1. PRELIMINARY

The following instructions are the procedures to be used if a scorer (separate from the referee) is assigned to the match. A referee who is also keeping score may modify these instructions in accordance with Tournament Regulations and/or tournament conditions.

2. BEFORE THE MATCH

- a. Use pen or pencil to record the match information in the heading section on the front of the score sheet. All proper names are in lowercase letters except for the first letter (e.g., Gulf Shores, AL; Apple, Bonnie). Do not fill in the “A” or “B” designations until after the coin toss.

Match #: from the tournament schedule

Beach: Beach name

Court: #

Date: DD/MM/YY (e.g., June 6, 2015 = 06/06/15)

Women, Men, Co-Ed: “X” the appropriate box

Level: Fill in the division information (e.g., Adult, Juniors with age description, Reverse, Co-Ed, Open, AA...)

Team: Last name, First name/Last name, First name (e.g., Franyon, Emily/Van-Miller, Beth). List players in the same order as shown on the tournament schedule (names should be in alphabetical order), with the higher-seeded team listed first. If necessary, the last name may be written above the first name.

(SEE EXAMPLE 2-1)

- b. In the **Player Name** section of the Teams box (lower left corner of the sheet with Set 3), print the players’ names in the same order as in the Heading, with the second name below the first.

(SEE EXAMPLE 2-2)

- c. In the **APPROVAL** box (lower right corner of the Set 3 side), fill in the officials’ names, using the format Last Name, First Name. Do not sign the score sheet until after the match is complete and you have verified the score sheet’s accuracy.

(SEE EXAMPLE 2-2)

- d. After the coin toss, find out from the referee(s) the following information:
- 1) which team won the coin toss: “X” that team’s Choice box in the Teams Section. Also record that team’s designation (A or B) at the bottom of the Remarks section for Set 1.

- 2) what each team chose for Set 1: record one of the following codes in the space behind each team's Choice Area
S = Serve **OR** R = Receive

A = Court on left side of scorer

OR

B = Court on right side of scorer

(From the perspective of player box area, if there are no player boxes then use the location of the scorer to determine side A or B.)

- e. The team that starts on the left side for Set 1 will be designated Team A for the entire match. Write the appropriate "A" or "B" in the circle next to the team names in the Heading and in the Results box. The team that serves first will be in the top portion of Set 1's scoring section (write the appropriate "A" or "B" in the Team circle next to Service Order I and III). The team that receives first will be in the lower portion of Set 1 (write the remaining team designation in the Team circle next to Service Order II and IV). **(SEE EXAMPLES 2-1 & 2-2)**
- f. After the coin toss, obtain each team captain's signature in the Captain's Pre-Match Signature area below the Player Name of the **TEAMS** box. The captain should also indicate the team's service order at this time. *Technique tip: You can write a small marker (e.g., asterisk, dot) next to the name of each team's first server in the player # Box. Write each player's name (Last Name, First Name) in the appropriate Player Identification box. Since players usually don't wear uniform numbers, write a useful identifier (e.g., knee brace, visor, braided hair) next to each name. It may be necessary to revise the identifying characteristic during the match (e.g., player removes visor or knee brace).
(SEE EXAMPLE 2-2)

EXAMPLE 2-1

USA VOLLEYBALL SCORESHEET - BEACH DOUBLES											
MATCH # 23		BEACH: Gulf Shores, AL		COURT # 1		DATE 07 / 06 / 15		<input type="checkbox"/> MEN <input checked="" type="checkbox"/> WOMEN <input type="checkbox"/> COED LEVEL:			
<input type="checkbox"/> CHOICE: _____ <input type="checkbox"/> CHOICE: _____		<input type="checkbox"/> CHOICE: _____ <input type="checkbox"/> CHOICE: _____		<input type="checkbox"/> CHOICE: _____ <input type="checkbox"/> CHOICE: _____		<input type="checkbox"/> CHOICE: _____ <input type="checkbox"/> CHOICE: _____		<input type="checkbox"/> CHOICE: _____ <input type="checkbox"/> CHOICE: _____		<input type="checkbox"/> CHOICE: _____ <input type="checkbox"/> CHOICE: _____	
<input checked="" type="radio"/> A Apple, Bonnie LAST NAME, FIRST NAME		<input type="radio"/> B Murmore, Suzanne LAST NAME, FIRST NAME		<input checked="" type="radio"/> A Franyon, Emily LAST NAME, FIRST NAME		<input type="radio"/> B Van-Miller, Beth LAST NAME, FIRST NAME					
TEAM SERVICE ORDER: I DELAY SANCTIONS: _____ TIME-OUT: _____		TEAM SERVICE ORDER: III DELAY SANCTIONS: _____ TIME-OUT: _____		TEAM SERVICE ORDER: II DELAY SANCTIONS: _____ TIME-OUT: _____		TEAM SERVICE ORDER: IV DELAY SANCTIONS: _____ TIME-OUT: _____		TEAM SERVICE ORDER: _____ DELAY SANCTIONS: _____ TIME-OUT: _____		TEAM SERVICE ORDER: _____ DELAY SANCTIONS: _____ TIME-OUT: _____	
MISCONDUCT SANCTIONS: _____ WARNING: _____ PENALTY: _____		MISCONDUCT SANCTIONS: _____ WARNING: _____ PENALTY: _____		MISCONDUCT SANCTIONS: _____ WARNING: _____ PENALTY: _____		MISCONDUCT SANCTIONS: _____ WARNING: _____ PENALTY: _____		MISCONDUCT SANCTIONS: _____ WARNING: _____ PENALTY: _____		MISCONDUCT SANCTIONS: _____ WARNING: _____ PENALTY: _____	
SET 1 START TIME: 1 2 3 4 5 6 7 8 9 10 11 12 13 14 15 16 17 18 END TIME: _____ DURATION: _____		SET 2 START TIME: 1 2 3 4 5 6 7 8 9 10 11 12 13 14 15 16 17 18 END TIME: _____ DURATION: _____		SET 3 START TIME: 1 2 3 4 5 6 7 8 9 10 11 12 13 14 15 16 17 18 END TIME: _____ DURATION: _____		SET 4 START TIME: 1 2 3 4 5 6 7 8 9 10 11 12 13 14 15 16 17 18 END TIME: _____ DURATION: _____		SET 5 START TIME: 1 2 3 4 5 6 7 8 9 10 11 12 13 14 15 16 17 18 END TIME: _____ DURATION: _____		SET 6 START TIME: 1 2 3 4 5 6 7 8 9 10 11 12 13 14 15 16 17 18 END TIME: _____ DURATION: _____	
TEAM POINTS: _____		TEAM POINTS: _____		TEAM POINTS: _____		TEAM POINTS: _____		TEAM POINTS: _____		TEAM POINTS: _____	
COURT SWITCH SCORE: _____ A : B : _____		COURT SWITCH SCORE: _____ A : B : _____		COURT SWITCH SCORE: _____ A : B : _____		COURT SWITCH SCORE: _____ A : B : _____		COURT SWITCH SCORE: _____ A : B : _____		COURT SWITCH SCORE: _____ A : B : _____	

EXAMPLE 2-2

TEAMS		Choice S (B) (A) Choice A	
No. *	Player Name	No.	Player Name
	Apple, Bonnie		Franyon, Emily
	Braids		Visor
	Murmore, Suzanne	*	Van-Miller, Beth
Captain's pre-match signature: <i>Suzanne Murmore</i>		Captain's pre-match signature: <i>Beth Van-Miller</i>	

3. DURING THE MATCH (SEE EXAMPLE 3-1)

- a. Record the time of the first service whistle/beckon in ink in the Set Start Time section (above the Service Round boxes). Format is HH:MM and 24-hour clock (e.g., 9:15 a.m. = 09:15; 3:28 p.m. = 15:28).
- b. The scorer is responsible for ensuring the players serve in the correct order. The scorer will make every effort to prevent a wrong server by informing the 2nd referee of the error before the serve occurs. If a player serves out of rotation and it is discovered after the ball has been put in play, the rally is stopped immediately and the correct server is allowed to serve. If the wrong server is discovered after the rally is completed, the correct player will serve the next ball. The team would keep any points earned with the “wrong server.” [EXCEPTION: If a player insists on serving out of order after being informed of the correct service order, the team is penalized with a loss of rally.]
*Technique tip: The scorer should call out the server’s name and the score before each service.
- c. The scorer monitors and records the results of each player’s term of service using the numbered Service Round boxes that extend to the right of each name (numbered 1 through 18).
 - 1.) When the first server (Service Order I) serves the ball to start the term of service, the scorer writes a small check mark (✓) over the “1” in the upper right corner of box 1. If the serving team wins the rally, the scorer slashes the earned point in the Team Points row (numbered 1 through 40) below the team’s Service Round boxes. If the same player continues to serve, no additional marks are recorded in that Service Round box until the team loses the serve.
 - 2.) At the loss of service, the scorer records the total cumulative score earned by the serving team (called the exit score) in the checked Service Round box. The scorer will also immediately record the rally point for the receiving team by slashing the appropriate point in the Team Points row below that team’s Service Round boxes.
 - 3.) The scorer repeats this process for the remaining Service Round 1 boxes, following the Service Order II, III and IV. When the player in Service Order I serves again, the scorer will use the Service Round 2 box, and so on.
- d. Court Switch
 - 1.) For the first two sets, the teams switch courts when the combined team scores equal multiples of seven (e.g., 2-5, 6-8,

10-11). For the deciding set, the teams switch courts when the combined team scores equal multiples of five (e.g., 3-2, 6-4, 9-6).

- 2.) The scorer should inform the 2nd referee (during the dead ball period) when the next rally will result in a court switch and, if needed, repeat the reminder at the time of the court switch.

*Technique Tip: Say “Point to switch” as the warning, and then “Switch” when the point has been scored.

- 3.) When the teams switch courts, the scorer records each team’s score in the **COURT SWITCH SCORE** box on the far right, making sure to enter team A’s score in the left column each time. If the teams switch courts and the combined team scores do not equal the correct multiple value, record the actual scores and note the discrepancy in the Remarks section (e.g., “Set 1, late court switch at 14 points, 8-7”). For set 1 or set 2, place an “X” in the appropriate **SEE REVERSE SIDE FOR COMMENTS** box.

- 4.) A technical time-out (TTO), if used, will occur at the third court switch of the first two sets. The third **COURT SWITCH SCORE** box is specially marked for this purpose. There will be no TTO in the deciding set. If a TTO is not used, draw a vertical line through the “TTO” next to the third **COURT SWITCH SCORE** box.

- e. Time-outs are recorded in the space below each team’s Service Order numbers and Team designation. The score at the time of a team’s time-out is recorded with the requesting team’s score listed first. At the beginning of the time-out period, discreetly signal to the referees the number of time-outs used by each team, matching the team information with the team bench location. If necessary, repeat the time-out information, this time matching the team information with the team location on the court.

f. Correcting Mistakes

- 1.) If the scorer makes an inadvertent error or the referee makes a mind change and the information is written in ink, the scorer must place an “X” through the error and neatly record the correct information immediately following the “X”. The scorer must not miss any action while making the correction.
- 2.) If the scorer makes an inadvertent error or if the referee makes a mind change and the information is recorded in pencil, the scorer may erase the error and record the correction. The scorer must not miss any action while making the correction.

- g. Set Point and Match Point: During the dead ball period, discreetly inform the referees when a team is one point away from winning the set or match. Repeat this information each time there is a new set point or match point situation.
- h. Misconduct and Team Delay
- 1.) Misconduct warning (individual yellow card) is recorded in the space to the right of the individual's Player Identification. Record the score at the time of the warning, with that team's score recorded first. No other action is taken against the team or player.
 - 2.) Misconduct penalty (individual red card) is recorded in the space to the right of the individual's Misconduct Warning box. A player may receive a penalty without previously receiving a warning and may receive a maximum of two penalties in the same set. Record the score at the time of the penalty (before the resultant loss of rally), with that team's score recorded first. Slash the next point of the opposing team, and circle that point to indicate it was earned through a penalty. In addition, the opposing team will serve the next ball. If the player receiving the penalty was on the serving team, record the exit score in the appropriate Service Round box. If the penalty results in a loss of rally before the penalized team has served, there will be no check mark in that Service Round box. NOTE: At the request of the tournament coordinator, individual red cards may be recorded in the Remarks section (e.g., "IRC, set 2, team A Emily Franyon, 15-14"). For set 1 or set 2, place an "X" in the appropriate **SEE REVERSE SIDE FOR REMARKS BOX.**
 - 3.) A player may be expelled (yellow and red cards in one hand) from a set, and the team is declared incomplete and must default the set. The expulsion and default **MUST** be recorded in the Remarks section (e.g., "Exp, set 2, team B Bonnie Apple, 17-15; Default, set 2, team B, 17-15"). For set 1 or set 2, place an "X" in the appropriate **SEE REVERSE SIDE FOR REMARKS** box. Give the opposing team the points needed to win the set by slashing the necessary points but do not circle these points.
 - 4.) A player may be disqualified (yellow and red cards held separately) for the match, and the team is declared incomplete and must default the remainder of the match. The disqualification and default must be recorded in the Remarks section (e.g., "DQ, set 2, team A Beth Van-Miller, 17-15; Default match, set 2, team A, 17-15"). For set 1 or set 2, place an "X" in the **SEE REVERSE SIDE FOR REMARKS** box.

Give the opposing team the points needed to win the match by slashing the necessary points but do not circle these points.

- 5.) Improper requests are not recorded on the score sheet.
 - 6.) Team delay warning (yellow card on opposite wrist) is recorded in the box to the right of the Time-Out box. Record the score at the time of the warning, with the score of the sanctioned team recorded first. No other action is taken against the team.
 - 7.) Team delay penalty (red card on opposite wrist) is recorded to the right of the Team Delay Warning box. Record the score at the time of the penalty (before the resultant loss of rally), with the sanctioned team's score recorded first. Slash the next point of the opposing team and circle this point to indicate it was earned through a penalty. In addition, the opposing team will serve the next ball. If the player receiving the penalty was on the serving team, record the exit score in the appropriate Service Round box. If the penalty results in a loss of rally before the penalized team has served, there will be no check mark in that Service Round box.
- h. Misconduct by a Head Coach
- The area provided on the back of the score sheet above the Remarks section will be used to record Misconduct warnings and penalties for Coaches using the following procedures:
- 1). Misconduct warning (individual yellow card) is recorded in the space to the right of the Coaches Team Identification box. Record the set number and score at the time of the warning, with that Coach's team score recorded first. No other action is taken against the team or Coach. Head Coach Team A receives a Warning at 13:14 in Set 1. Note: this is not recorded in the Remarks box.
 - 2). Misconduct penalty (individual red card) is recorded in the space to the right of the Coach's Misconduct Warning box. A Coach may receive a penalty without previously receiving a warning and may receive a maximum of one (1) penalty in the same MATCH. Record the score at the time of the penalty (before the resultant loss of rally), with that Coach's team score recorded first. Slash the next point of the opposing team, and circle that point to indicate it was earned through a penalty. In addition, the opposing team will serve the next ball. If the Coach receiving the penalty was on the serving team, record the exit score in the appropriate Service Round box. If the penalty results in a loss of rally before the penalized team has served, there will be no check mark in that Service Round box. Asst. Coach Team B receives a

Penalty 14:14 in Set 1. Note: This CAN BE recorded in the Remarks box.

- A Coach may be expelled (yellow and red cards in one hand) from a set, and must leave the court and immediate vicinity for that set. The expulsion MUST be recorded in the Remarks section (e.g., “Exp, Set 2, Team B, Head Coach, 17-15”). For Set 1 or Set 2, place an “X” in the appropriate **SEE REVERSE SIDE FOR REMARKS** box. No further action is taken against the team.
- A Coach may be disqualified (yellow and red cards held separately) for the match, and must leave the competition site until the conclusion of the match. The disqualification MUST be recorded in the Remarks section (e.g. “DQ, Set 3, Team B, Asst. Coach, 7-8”). For Set 1 or Set 2, place an “X” in the **SEE REVERSE SIDE FOR REMARKS** box. No further action is taken against the team.(**SEE EXAMPLE 3-2**)

EXAMPLE 3-1

USA VOLLEYBALL SCORESHEET - BEACH DOUBLES											
MATCH #	23	BEACH:	Gulf Shores, AL	COURT #	1	DATE	07/06/15	MEN	<input type="checkbox"/>	WOMEN	<input checked="" type="checkbox"/>
CHOICE:	S	CHOICE:	A	CHOICE:	A	CHOICE:	J	COED LEVEL:	J		
TEAM	B	Apple, Bonnie	Murmore, Suzanne	TEAM	A	Franyon, Emily	Van-Miller, Beth				
LAST NAME, FIRST NAME	ORDER	LAST NAME, FIRST NAME	ORDER	LAST NAME, FIRST NAME	ORDER	LAST NAME, FIRST NAME	ORDER				
SET	I	Apple, Bonnie	Breeds	SET	II	Van-Miller, Beth	Tateoss				
SCORE	13:9	Murmore, Suzanne		SCORE	13:9	Franyon, Emily	Vieff				
TIME OUT	2:47:10	POINTS	11:11:10	TIME OUT	2:57:11	POINTS	11:10				
SEE REVERSE SIDE FOR REMARKS											
TEAM	A	Franyon, Emily	Van-Miller, Beth	TEAM	B	Apple, Bonnie	Murmore, Suzanne				
SCORE	11:10	POINTS	11:10	SCORE	13:9	POINTS	11:10				

EXAMPLE 3-2

Team	A	13:14	Penalty	Score	2:17:17	Expulsion	Score	1:14:14	Disqual.	Score	3:7:8
Head Coach	B		Team	A		Team	B				
Coach			Coach	Asst.		Coach					
Remarks: Additional information attached											
Exp, Set 2, Team B, Head Coach, 17-17											
DQ, Set 3, Team B, Asst. Coach, 7-8 Physical Aggression											

4. POST-SET PROCEDURES

- a. When the referee blows the whistle to end the last rally of the set, slash the winning point in the Team Points row. Record this final point as the exit score for the winning team. If the receiving team earned the winning point from the opponent's loss of service, record the winning point in the Service Round box of the player who would have been the next server and do not make a check mark in the upper right corner of the box. Additionally, record the appropriate exit score in the Service Round box of the losing team's last server.
- b. The "end of set" signal by the 1st referee marks the time the set ended. Record the time (using the 24-hour clock format, HH:MM) in the Set End Time space, located to the right of the Set Start Time space.
 - 1.) Calculate the duration of the set by determining the elapsed time between the Set Start Time and Set End Time. Record this data in minutes in the Set Duration space to the right of Set End Time.
- c. Circle the final exit score (in the Service Round box) for each team and write each team's score in the appropriate Team Points box, located to the left of the Team Points row. **(SEE EXAMPLE 4-1)**
- d. Transfer each team's set information: number of time-outs, wins, set duration and the points scored to the appropriate columns in the Results section. **(SEE EXAMPLE 4-2)**
- e. Cancel the unused **COURT SWITCH SCORE** boxes by drawing a single large X through the empty boxes. Also, cancel each team's unearned points by drawing a vertical line immediately to the right of the last slashed point, then drawing a horizontal line through unearned points (similar to a sideways "T".) **(SEE EXAMPLE 4-1)**
- f. The interval between set 1 and set 2 is one minute. The scorer should add one minute to the previous Set End Time and record this time as the Set Start Time for Set 2. At this time, "X" the Choice box for the team that lost the coin toss for Set 1.
*Technique Tip: This "X" can be placed on the score sheet during the time you are filling in the set 1 information.
- g. The team that lost the coin toss for set 1 can choose one of the following: (1) to serve or receive, or (2) the side of the court on which to start the set. The other team will select the remaining

choice. Therefore, the scorer must wait for these decisions before preparing set 2. Record the appropriate code (see paragraph 2.d.2) in the space behind each team's Choice for set 2. Each captain will also indicate the service order, which may be different from the previous set. Once the scorer has the necessary data, fill in the scoring section for set 2, remembering that the teams retain their original "A" and "B" designations. Record the set 2 action, using the same match and post-set procedures described above. **(SEE EXAMPLE 4-3)**

- h. Deciding Set: If the teams are tied 1-1 after set 2, the 2nd referee will conduct a coin toss for the deciding set. In the absence of a 2nd referee, the 1st referee will conduct this coin toss.
 - 1.) Flip the score sheet to the set 3 side. The interval between set 2 and set 3 is one minute. To indicate which team won the coin toss, "X" that team's Choice box at the top of the sheet with set 3. Also record that team's designation (A or B) at the bottom of the Remarks section for set 3. Using the coin toss results, prepare the scoring section accordingly.
 - 2.) Record the set 3 action, using the same match and post-set procedures described above, except the teams will switch courts when the combined scores equal multiples of five.

EXAMPLE 4-1

USA VOLLEYBALL SCORESHEET - BEACH DOUBLES														
MATCH # 23		BEACH: Gulf Shores, AL			COURT # 1	DATE 07 / 06 / 15			<input type="checkbox"/> MEN <input checked="" type="checkbox"/> WOMEN					
CHOICE: S		CHOICE: A			<input type="checkbox"/> COED LEVEL:									
B Apple, Bonnie		Murmure, Suzanne			A Franyon, Emily		Van-Miller, Beth							
LAST NAME, FIRST NAME		LAST NAME, FIRST NAME			LAST NAME, FIRST NAME		LAST NAME, FIRST NAME							
SET	TEAM SERVICE ORDER	PLAYER IDENTIFICATION	MISCONDUCT SANCTIONS WARNING PENALTY PENALTY		SET START TIME	SET END TIME	SET DURATION	(MINS)		COURT SWITCH SCORE				
	B I	Apple, Bonnie Braids	13:14	:	:	15:32	15:55	23		A : B	7			
	III	Murmure, Suzanne	:	:	:	1 3 5 9 12 16 18	8 9 10 11 12 13 14 15 16 17 18			3 : 4	7			
	II		:	:	:	2 4 7 10 15 17 19	8 9 10 11 12 13 14 15 16 17 18			7 : 7	14			
TIME-OUT		DELAY SANCTIONS WARNING PENALTY PENALTY		TEAM POINTS	SEE REVERSE SIDE FOR REMARKS								11:10 21	
12:14		:		19									14:14 28	
1	TEAM SERVICE ORDER	PLAYER IDENTIFICATION	MISCONDUCT SANCTIONS WARNING PENALTY PENALTY										18:17 35	
	A II	Van-Miller, Beth Tattoos	:	:	:	1 3 6 9 14 18 20	8 9 10 11 12 13 14 15 16 17 18			:	42			
	IV	Franyon, Emily Visor	14:14	:	:	2 5 7 11 17 19 21	8 9 10 11 12 13 14 15 16 17 18			:	49			
	:	:	:	:	:						:	56		
TIME-OUT		DELAY SANCTIONS WARNING PENALTY PENALTY		TEAM POINTS									70	
		:		21									77	

EXAMPLE 4-2

RESULTS	Time-Outs	Wins	Points	Set Duration	Points	Wins	Time-Outs
	1	0	19	Set 1 (<u>23</u> mn)	21	1	0
				Set 2 (_____ mn)			
				Set 3 (_____ mn)			
	Total	Total	Total	Total (_____ mn)	Total	Total	Total
	Match starting time ____ h ____ mn		Total Match Duration _____ h ____ mn			Match ending time ____ h ____ mn	
Winning team _____ / _____ 2 : _____							

EXAMPLE 4-3

CHOICE: A CHOICE: R

TEAM	SERVICE ORDER	PLAYER IDENTIFICATION	MISCONDUCT SANCTIONS			SET START TIME	SET END TIME	SET DURATION	COURT SWITCH SCORE
			WARNING	PENALTY	PENALTY				
B	I	Murmore, Suzanne	:	:	:	15:56	16:19	23	A : B
	III	Apple, Bonnie Braids	:	:	:	4 9 13 19 (21)	6 7 8 9 10 11 12 13 14 15 16 17 18	5:9	7
						7 11 17 20	5 6 7 8 9 10 11 12 13 14 15 16 17 18	5:9	14
TIME OUT			DELAY SANCTIONS			TEAM POINTS: 21			10:11
			WARNING PENALTY PENALTY						12:16
									15:20
A	II	Franyon, Emily Brace	:	:	:	2 6 12 15	5 6 7 8 9 10 11 12 13 14 15 16 17 18		42
	IV	Van-Miller, Beth Tattoos	:	:	:	4 10 13 19	5 6 7 8 9 10 11 12 13 14 15 16 17 18		49
									56
TIME OUT			DELAY SANCTIONS			TEAM POINTS: 19			63
			WARNING PENALTY PENALTY						70
									77

SEE REVERSE SIDE FOR REMARKS

5. POST-MATCH PROCEDURES

- In the **RESULTS** box, calculate and record the Total Duration in minutes, including the interval between sets. Write the name of the Winning Team, listing the names in the same order as in the Heading (last names only is acceptable). Behind the team name, record the set scores, with the match winner's scores listed first. Take care to use the data in the Points column and not the Duration column. **(SEE EXAMPLE 5-1)**
- Review the score sheets to verify they are accurate and complete, then sign beside your printed name.
- The 2nd referee and then the 1st referee will check and then sign the score sheet beside their printed names.
- Deliver the completed score sheet to the Tournament Director.
- If there has been a match interruption, which increased the overall match time, the set in which it occurred will be marked with an * in the appropriate set duration box. Also an explanation may be placed in the Remarks section: (e.g., Match delayed due to lightning Set 3, A players request for Medial Assistance...)

EXAMPLE 5-1

		Time-Outs	Wins	Points	Set Duration	Points	Wins	Time-Outs
RESULTS	1	0	19	Set 1 (_23_ mn)	21	1	0	0
	1	1	21	Set 2 (_23_ mn)	19	0	1	1
	1	0	10	Set 3 (_20_ mn)*	15	1	0	0
	Total	3	Total 1	Total 50	Total (_66_ mn)	Total 55	Total 2	Total 1
	Match starting time 15 h 32 min		Total Match Duration _1_ h _8_ mn				Match ending time 16 h 40 min	
Winning team <u>Franyon</u> / <u>Van-Miller</u> 2: <u>1</u>								
APPROVAL	Officials		Printed Name			Signature		
	1 st Referee		Mayers, Kathryn			<i>K. Mayers</i>		
	2 nd Referee		Webb, Robert			<i>Robert Webb</i>		
	Scorer		Grambino, James			<i>James Grambino</i>		

6. INJURY RECOVERY TIME PROCEDURES

After authorization from the Referee, an injured player is allowed one five-minute injury recovery period per match. The details regarding this interruption must be recorded accurately.

- a. The following game facts must be recorded in the Comments Section: Time of Day, Set Number, Set Score, Serving Team, and Which Player Needed Medical Assistance.
- b. The time the Accredited Medical Staff arrives must be recorded (the injury recovery period begins at this time).
- c. The time that the Accredited Medical Staff finishes treating the player and the match resumes must be recorded as well. (The treatment time will not exceed five minutes). The total duration of the match interruption is recorded. **(SEE EXAMPLE 6-1)**
- d. If the player elects to treat the injury without Medical Assistance, the five-minute injury recovery period begins upon Referee authorization. This time will be noted, in the same manner as 6.a.

EXAMPLE 6-1

Remarks:	Additional information attached <input type="checkbox"/>
16:27:08, 3rd SET, 8-10, TEAM A SERVING, TEAM B	
MURMORE, SUZANNE REQUESTS MEDICAL ASSISTANCE.	
16:28:30, MEDICAL ARRIVES (START OF 5 MINUTE MEDICAL TIME OUT).	
16:33:30, MATCH RESUMED.	
DURATION 00:06:22.	
Winner of Coin Toss: A or B Set 1 (B) Set 3 (A)	

- e. If the player changes his/her mind and requests Medical Assistance, the recovery period will be suspended and the Accredited Medical Staff will be called. The time of this new request will be recorded and the elapsed time noted.
- f. The recovery period will resume when the Accredited Medical Staff arrives. The Accredited Medical Staff will be allowed to treat the injured player using the remainder of the recovery period. The arrival time of the Accredited Medical Staff must be recorded.
- g. The time that the Accredited Medical Staff finishes treating the player and the match resumes must be recorded as well. (This treatment time will not exceed five minutes.) The total duration of the match interruption is recorded. **(SEE EXAMPLE 6-2)**

EXAMPLE 6-2

Remarks:	<small>Additional information attached</small> <input type="checkbox"/>
16:27:15, 3rd SET, 8-10, TEAM A SERVING, TEAM B MURMORE, SUZANNE REQUESTS MEDICAL TIME-OUT.	
16:29:15, TEAM B MURMORE, SUZANNE REQUESTS MEDICAL ASSISTANCE (ELAPSED TIME 00:02:00).	
16:32:15, MEDICAL ARRIVES (RESUME 5 MINUTE MEDICAL TIME OUT).	
16:35:00, MATCH RESUMED.	
DURATION 00:07:45.	
Winner of Coin Toss: A or B Set 1 (B) Set 3 (A)	

CHOICE: A

CHOICE: R

TEAM	SERVICE ORDER	PLAYER IDENTIFICATION	MISCONDUCT SANCTIONS WARNING PENALTY	SET START TIME	SET END TIME	SET DURATION	COURT LIGHT SCORE
S E T	I	Apple, Bonnie, Broids	:	16:20	16:40	20	A : B 2 : 3 5 8 : 7 10
	III	Murmore, Suzanne	:	0:6	8:10	14	
		DELAY SANCTIONS WARNING PENALTY	:	0:0	:	:	
		TEAM POINTS	17 8 9 5 6 7 8 9 10	11 12 13 14 15 16 17 18 19 20 21 22 23 24 25 26 27 28 29 30 31 32 33 34 35 36 37 38 39 40			11 : 9 20

TEAM	SERVICE ORDER	PLAYER IDENTIFICATION	MISCONDUCT SANCTIONS WARNING PENALTY	SET START TIME	SET END TIME	SET DURATION	COURT LIGHT SCORE
3	II	Van-Miller, Beth Tattoos	:	10:15	10:35	20	A : B 40 45 50 55
	IV	Franyon, Emily	:	4:8	8:13	18	
		DELAY SANCTIONS WARNING PENALTY	:	0:0	:	:	
		TEAM POINTS	15				

<input checked="" type="checkbox"/> Choice S <input type="checkbox"/> Choice A	
No.	Player Name
*	Apple, Bonnie
*	Murmore, Suzanne
CAPTAIN'S PREMATCH SIGNATURE: <i>Suzanne Murmore</i>	

TEAMS	Time-Outs	Wins	Points	Set Duration	POINTS		Wins	Time-Outs
					Team	Opponent		
1	0	19	Set 1 (: 23 min)	21	1	0		
1	1	21	Set 2 (: 23 min)	19	0	1		
1	0	10	Set 3 (: 20 min)	15	1	0		
TOTAL	3	50	Total (: 66 min)	55	2	1		
WINNING TIME 15 h 32 min		Total Match Duration 1 h 8 min		16 h 40 min				

Winning team	Franyon / Van-Miller	2 : 1
Officials	Printed Name	Signature
1 st Referee	Mayers, Kathryn	<i>K. Mayers</i>
2 nd Referee	Webb, Robert	<i>Robert Webb</i>
Scorer	Grambino, James	<i>JAMES GRAMBINO</i>

Remarks: Additional information attached

IRC, Set 1, Team B, Emily Franyon, 14-14 Profanity
 3rd Set Team "B", Murmore, IRC, Abuse of Equipment
 (After The Conclusion of Set 2)
 16:27:08 3rd Set, 8-10 Team "A" Serving,
 Team "B" Murmore, Suzanne Requests Medical Assistance
 16:28:30 Medical Arrives (Start 5 Minute Medical T/O)
 16:33:30 Match Resumed
 Duration 00:05:52

USA VOLLEYBALL SCORESHEET - BEACH DOUBLES

MATCH # _____ BEACH: _____ COURT # _____ DATE _____ DAY _____ MONTH _____ YEAR _____ MEN WOMEN
 CHOICE: _____ CHOICE: _____ COED LEVEL: _____
 A B A B

TEAM	SERVICE ORDER	PLAYER IDENTIFICATION	LAST NAME FIRST NAME	LAST NAME FIRST NAME	SET DURATION (MINS.)	COURT SWITCH SCORE
S E T	I	1 2 3 4 5 6 7 8 9 10 11 12 13 14 15 16 17 18	A : B : 7 : 14 : 21 : 28 : 35 : 42 : 49 : 56 : 63 : 70 : 77
	III	1 2 3 4 5 6 7 8 9 10 11 12 13 14 15 16 17 18	
	TIME-OUT	DELAY SANCTIONS WARNING PENALTY PENALTY		TEAM POINTS:		
MISCONDUCT SANCTIONS WARNING PENALTY PENALTY <input type="checkbox"/> SEE REVERSE SIDE FOR REMARKS						
1	II	1 2 3 4 5 6 7 8 9 10 11 12 13 14 15 16 17 18	
IV	1 2 3 4 5 6 7 8 9 10 11 12 13 14 15 16 17 18	
TIME-OUT	DELAY SANCTIONS WARNING PENALTY PENALTY		TEAM POINTS:			

CHOICE: _____ CHOICE: _____

TEAM	SERVICE ORDER	PLAYER IDENTIFICATION	LAST NAME FIRST NAME	LAST NAME FIRST NAME	SET DURATION (MINS.)	COURT SWITCH SCORE
S E T	I	1 2 3 4 5 6 7 8 9 10 11 12 13 14 15 16 17 18	A : B : 7 : 14 : 21 : 28 : 35 : 42 : 49 : 56 : 63 : 70 : 77
	III	1 2 3 4 5 6 7 8 9 10 11 12 13 14 15 16 17 18	
	TIME-OUT	DELAY SANCTIONS WARNING PENALTY PENALTY		TEAM POINTS:		
MISCONDUCT SANCTIONS WARNING PENALTY PENALTY <input type="checkbox"/> SEE REVERSE SIDE FOR REMARKS						
2	II	1 2 3 4 5 6 7 8 9 10 11 12 13 14 15 16 17 18	
IV	1 2 3 4 5 6 7 8 9 10 11 12 13 14 15 16 17 18	
TIME-OUT	DELAY SANCTIONS WARNING PENALTY PENALTY		TEAM POINTS:			

TEAM	SERVICE ORDER	PLAYER IDENTIFICATION	MISCONDUCT SANCTIONS			SET START TIME:	SET END TIME:	SET DURATION:	COURT SWITCH SCORE														
			WARNING	PENALTY	PENALTY					(MINS.)													
S	I		1	:	:	1	2	3	4	5	6	7	8	9	10	11	12	13	14	15	16	17	18
			2	:	:	1	2	3	4	5	6	7	8	9	10	11	12	13	14	15	16	17	18
T	III		1	:	:	1	2	3	4	5	6	7	8	9	10	11	12	13	14	15	16	17	18
			2	:	:	1	2	3	4	5	6	7	8	9	10	11	12	13	14	15	16	17	18
		DELAY SANCTIONS	TEAM POINTS:			1 2 3 4 5 6 7 8 9 10 11 12 13 14 15 16 17 18 19 20 21 22 23 24 25 26 27 28 29 30 31 32 33 34 35 36 37 38 39 40																	
		DELAY SANCTIONS	TEAM POINTS:			1 2 3 4 5 6 7 8 9 10 11 12 13 14 15 16 17 18 19 20 21 22 23 24 25 26 27 28 29 30 31 32 33 34 35 36 37 38 39 40																	
		DELAY SANCTIONS	TEAM POINTS:			1 2 3 4 5 6 7 8 9 10 11 12 13 14 15 16 17 18 19 20 21 22 23 24 25 26 27 28 29 30 31 32 33 34 35 36 37 38 39 40																	

TEAM	SERVICE ORDER	PLAYER IDENTIFICATION	MISCONDUCT SANCTIONS			SET START TIME:	SET END TIME:	SET DURATION:	COURT SWITCH SCORE														
			WARNING	PENALTY	PENALTY					(MINS.)													
3	II		1	:	:	1	2	3	4	5	6	7	8	9	10	11	12	13	14	15	16	17	18
			2	:	:	1	2	3	4	5	6	7	8	9	10	11	12	13	14	15	16	17	18
		DELAY SANCTIONS	TEAM POINTS:			1 2 3 4 5 6 7 8 9 10 11 12 13 14 15 16 17 18 19 20 21 22 23 24 25 26 27 28 29 30 31 32 33 34 35 36 37 38 39 40																	
		DELAY SANCTIONS	TEAM POINTS:			1 2 3 4 5 6 7 8 9 10 11 12 13 14 15 16 17 18 19 20 21 22 23 24 25 26 27 28 29 30 31 32 33 34 35 36 37 38 39 40																	

Choice	<input type="radio"/>	<input type="radio"/>	<input type="radio"/>	<input type="radio"/>	Choice
No. 1	Player Name	No. 2	Player Name		
Captain's pre-match signature: _____					
Captain's pre-match signature: _____					
Remarks: _____					
Additional information attached <input type="checkbox"/>					

Time-Outs	Wins	Points	Set Duration	Points	Wins	Time-Outs
			Set 1 (____ mm)			
			Set 2 (____ mm)			
			Set 3 (____ mm)			
Total	Total	Total	Total (____ mm)	Total	Total	Total
Match starting time _____ h _____ mn			Match ending time _____ h _____ mn			
Winning team _____ / _____ 2 :						

Officials	Printed Name	Signature
1 st Referee		
2 nd Referee		
Scorer		

Winner of Coin Toss: A or B Set 1 Set 3

**USAV GUIDELINES FOR THREE-PLAYER (TRIPLES),
FOUR-PLAYER (QUADS), SIX-PLAYER (SIXES),
INCLUDING CO-ED AND REVERSE CO-ED**

Lines on the Court, Rule 1.3: For Reverse Co-Ed Doubles and all Six-player Competition only: Attack lines are marked 3 m (9'10") from the center line to the rear of the attack line.

Net Heights, Rule 2.1: Co-Ed 2.43 m (7'11^{5/8}"), Reverse Co-Ed 2.24 m (7'4^{1/8}")

Team Composition, Rule 4.1:

- For Triples: three players and two substitutes maximum.
- Quads: four players and two substitutes maximum.
- Sixes: six players and six substitutes maximum.
- Players are the team members on the team court.
- Substitutes are team members in uniform who are not in the starting line-up of a set.
- All competitions must involve teams with the required number of players.
- Teams with fewer than the required number of players are incomplete and forfeit the set or match.
- Only players and substitutes recorded on the roster may participate in the match.
- The roster shall be written prior to the start of each match on the score sheet for the first set of the match.
- Once the team captain or coach has signed the roster, the recorded players and substitutes cannot be changed.
- Men's teams are composed of male players competing on a 2.43 m (7'11^{5/8}") net.
- Women's teams are composed of female players competing on a 2.24 m (7'4^{1/8}") net.
- Co-Ed teams are composed of male and female players competing on a 2.43 m (7'11^{5/8}") net.
- Reverse Co-Ed teams are composed of male and female players competing on a 2.24 m (7'4^{1/8}") net.
- For Co-Ed or Reverse Co-Ed Doubles, Quads or Sixes competition only:
 - Teams must contain equal numbers of males and females on each team, unless otherwise specified in the Tournament Regulations.
- For Co-Ed or Reverse Co-Ed Triples competition only:
 - Each team must contain at least one male and at least one female player. Unless otherwise specified in the Tournament Regulations, opposing teams need not contain equal numbers of males and females.

Substitution guidelines: For Triples, Quads or Sixes Competition only:

- Unlimited substitutions are allowed as long as one player does not occupy more than one position in the service order during a single set.
- If a player becomes injured and no legal substitute is available for that position in the service order, a player on the roster not playing at the time of the injury may enter the set as an exceptional substitution for the injured player.
- This substitute may not be replaced for the remainder of the set, unless s/he also becomes injured.
- If no team members are available to make a legal or exceptional substitution, an injury time-out may be granted.

Positional Faults, Rule 7.5: For Sixes Competition only: At the time the ball is contacted for service, the placement of players must conform to the service order recorded on the scoresheet as follows:

In the front or back row, the center player may not be as near the right sideline as the right player nor as near the left sideline as the left player. No back-row player may be as near the net as the corresponding front row player.

The server is exempt from these restrictions. After the ball is contacted for service, players may move from their respective positions. A captain may request the scorer to indicate which player should be serving for his/her team.

Service Order, Rule 12.2.2.2: For Triples, Quads and Sixes Competition only: Servers must serve according to the service order as recorded on the score sheet (See Rule 7.7).

Attack Hit Faults, Rule 13.2.3: For Doubles, Triples and Quads Competition only: Directs an attack-hit with the fingers, using an “open-hand tip” or “dink.”

FOR SIXES COMPETITION ONLY: THIS RULE DOES NOT APPLY.

Attack Hit Faults, Rule 13.2.5: For Doubles and Triples Competition only: A player intentionally completes an attack-hit using an overhand set that gives the ball a trajectory not perpendicular to the line of the player’s shoulders except when setting his or her teammate.

For Back-Row Players in Sixes competition and Males in Reverse Co-Ed competition only: Contacts the ball completely above the height of the net, while his/her foot is touching or has last touched the ground on or in front of the attack line and does not direct the attack-hit with an upward trajectory.

ABBREVIATIONS

m	=	meter
'	=	foot (feet)
cm	=	centimeter
"	=	inches
gm	=	grams
mbar	=	millibars
kg/cm ²	=	kilograms per square centimeter
lbs/sq in	=	pounds per square inch
lbs/sq in	=	68.0
mbar	=	0.0703 kg/cm ²
°C	=	degrees Celsius
°F	=	degrees Fahrenheit

METRIC CONVERSIONS (INCLUDING STANDARD FOR DOUBLES & TRIPLES PLAY AND STANDARD FOR QUADS & SIXES PLAY)

Standard for Doubles & Triples

Length of playing court	16 m	=	52'6"
Width of playing court	8 m	=	26'3"
Diagonal of full playing court	17.89 m	=	58'8"
Diagonal of half playing court	11.31 m	=	37'1"
Minimum length of net	8.5 m	=	27'10 ^{1/2} "
Minimum width of free zone	3 m	=	9'10"
Recommended height of posts	2.55 m	=	8'4"
Height of men's net	2.43 m	=	7'11 ^{5/8} "
Height of women's net	2.24 m	=	7'4 ^{1/8} "
Height of 12 & under net	2.13 m	=	6'11 ^{1/2} "
Height of 10 & under net	1.98 m	=	6'6"
Length of antenna	1.8 m	=	5'11"
Net width:			
Max. side line-post distance	1 m	=	39"
Length of antenna above net	0.8 m	=	32"
Circumference of ball	65-67 cm	=	25.5-27"
Referee's view above net	50 cm	=	19 ^{1/2} "
Sand depth:			
Recommended min. sand depth	30 cm	=	12"
Min. side line to post distance	70 cm	=	27 ^{1/2} "
Size of net mesh squares	10 cm	=	4"
Max. width of side line band	8 cm	=	3 ^{1/8} "
Min. width of side line band	5 cm	=	2"
Max. width of side line rope	1 cm	=	3/8"
Min. width of side line rope	0.5 cm	=	3/16"
Max. difference of net height			
From side line to center	2 cm	=	3/4"
Min. temperature	10° C	=	50° F
Weight range of ball	260-280 gm	=	0.5-0.6 lb
Internal air pressure of ball			
(outdoor)	0.175-0.225 kg/cm ²	=	2.5-3.2 lb/sq in
Min. light at 1 m above court	300 lux	=	27.9 foot candles
Standard for Quads & Sixes			
Length of playing court	18 m	=	59'
Width of playing court	9 m	=	29'6"
Diagonal of half the			
playing court	12.728 m	=	41'8 ^{1/2} "
Minimum length of net	9.75 m	=	32'

GUIDELINES FOR BEACH (OUTDOOR) VOLLEYBALL TOURNAMENTS

MATCH WARM-UP

Ten minutes are allowed for warm-up. Formally, this period includes three minutes of free ball handling, the coin toss, and five minutes of formal timed warm up. Teams share the entire court throughout the 10-minute period. Coaches are not allowed on court once the 10-minute period begins.

In Regional play, a less formal procedure may be used. Tournament Directors are allowed to adjust these protocols as necessary. (As a general guideline, allow no more than 10 to 12 minutes between matches.)

Formal Warm-Up Protocol

- 10 Teams on shared court (in uniform, without coaches)
- 7 Coin toss
- 6 Start five-minute timed warm-up (shared)
- 1 End warm-up, teams to benches, referee to stand
- 0 Teams to end-lines
- R1 invites teams to net to shake hands
- Start match

FORFEIT PROCEDURES

When the match start has been called up, a late or incomplete team forfeits set 1. The late or incomplete team will have 10 minutes before forfeiting set 2 and the match. If the late or incomplete team arrives with sufficient players before the 10-minute period has elapsed, they will be allowed to warm up during the remaining time.

These procedures should be published and announced to the participating teams.

TEAM OFFICIATING PROCEDURES

In pools, the refereeing duties are assigned. In an elimination bracket, the losing team referees the next match.

During pool play, referee duties are pre-scheduled along with the play schedule. During elimination (bracket) play, use the "losing team refs the next match on their court" as a guiding principle.

Failure to referee should have pre-announced penalties.

Each court should have a clipboard, pool chart and pencil, and a team on that court in charge of posting the match results. The work team should return the pool sheets to the Tournament Director.

OPTIMUM POOL DESIGNATIONS

Waiting list teams should not be accepted unless the addition creates a desirable number of teams. In large events (30 or more teams), only four-team pools should be used or very good court supervision is required.

While pools of four are the ideal number, you can put more teams on a court, using pools of five, if space is limited. Many tournaments have four-team pools that play only two sets to 21 points instead of best-two-of-three matches.

When the same division has pools with different numbers of teams, the point differential should be calculated as the average point differential per set. This will account for the pools playing different numbers of sets during pool play.

Four-team pool

1 vs. 4 (2)
2 vs. 3 (1)
1 vs. 3 (4)
2 vs. 4 (3)
3 vs. 4 (2)
1 vs. 2 (3)

Five-team pool

2 vs. 5 (4)
3 vs. 4 (2)
1 vs. 5 (3)
2 vs. 3 (5)
1 vs. 4 (2)
3 vs. 5 (1)
2 vs. 4 (3)
1 vs. 3 (5)
4 vs. 5 (1)
1 vs. 2 (4)

Six-team pool (on two courts)

(1)	1 vs. 6 (4)	2 vs. 5 (3)
(2)	3 vs. 4 (2)	1 vs. 5 (6)
(3)	4 vs. 6 (5)	2 vs. 3 (1)
(4)	1 vs. 4 (6)	3 vs. 5 (2)
(5)	2 vs. 6 (4)	1 vs. 3 (5)
(6)	2 vs. 4 (1)	5 vs. 6 (3)
(7)	1 vs. 2 (4)	3 vs. 6 (5)
(8)	4 vs. 5 (3)	

SUGGESTED TIE-BREAKER PROCEDURES

Teams are tied if they have the same match win-loss record (if pool used match play) or same set win-loss record (if pool did not use match play). In case of ties, use the following recommended tie-breaking procedures. Teams should not be eliminated from assignment to championship competition on a point or any other non-competitive system.

Two teams tied and two teams advance:

In priority order: head-to-head match result; overall point differential; coin toss.

Two teams tied and one team advances:

Head-to-head match result (if pool used match play) or head-to-head sets (if pool did not use match play). If teams are tied head-to-head sets, then the two teams will play one 15-point rally-score set. The winning team will advance.

Three teams tied and two teams advance:

- a. Seed the teams using, in priority order, overall set winning percentage; overall point differential.
- b. The top seed will advance. The teams seeded second and third will play one 15-point rally-score set, with the winner advancing. The top seed will officiate this tie-breaker set.

Three teams tied and one team advances:

- a. Seed the teams using, in priority order, overall set winning percentage; overall point differential.
- b. There will be two tie-breaker sets (15 points, rally scoring). The teams seeded second and third will play the first set and the top seed will officiate.
- c. The winner of the first tie-breaker set will play the top seed and the losing team from the first set will officiate. The winner of the second set advances.

Tie-breaking procedures for situations involving four or more teams should be written and announced in advance to the participating teams.

GUIDE TO PHYSICALLY CHALLENGED BEACH VOLLEYBALL

Sitting and standing Beach Volleyball are officially recognized by World Paravolley (WPV). A beach World Championships will be held in 2016. Although it is not yet a Paralympic sport, the WPV is hoping to get Beach Volleyball accepted into the 2020 Paralympic Games in Tokyo. For more information, log onto www.worldparavolley.org.

INDEX

OUTDOOR RULES

A

Additional Equipment	8
Antennae	7
Attack-Hit	22
Authorization of the service	21

B

Ball at the net	18
Ball crossing the net	18
Ball “in”	16, 51, 55
Ball in play	16
Ball in the net	19
Ball “out”	16, 51, 55
Ball out of play	16
Ball touching the net	19
Balls	8
Block	23, 45
Block and team hits	23
Block contact	23
Blocking	23, 51
Blocking faults	24, 51
Blocking the service	24
Blocking within the opponent’s spae.	23

C

Captain	11
Change of courts/switches	28, 48
Change of equipment	10
Characteristics of the attack-hit	22
Characteristics of the hit	17
Contact with the net	20

D

Default and incomplete team	13
Delay sanctions	26
Dimensions	4

E	
Equipment	10
Exceptional game interruption	26
Execution of the service	21
External interference	27
F	
Fair play	29
Faults in playing the ball	18
Faults made during the service	22
Faults of the attack-hit	22
First Referee	33
–Authority	33
–Location	33
–Responsibilities	34
First service in a set	20
Forbidden objects	10
G	
Game delays	26
Game interruptions	25
H	
Height of the net	5
I	
Improper request	25
Injury/illness	26
Interruptions	25
Intervals	28
Intervals and court switches	28
L	
Lighting	5
Line Judges	38, 55-56
–Location	38
–Responsibilities	38
Line judges' flag signals	38, 55-56
Lines on the court	5
Location of the team	10

M	
Minor misconduct	29
Misconduct and its sanctions	29
Misconduct before and between sets	30
Misconduct leading to sanctions	29

N	
Net and posts	5
Number of regular game interruptions	25

O	
Official signals	39, 48-54, 55-56
Official warm-up session	14

P	
Players' faults at the net	20
Playing area	4, 40
Playing surface	4
Playing the ball	16
Positions	14
Positional fault	14
Posts	5
Prolonged interruptions	27

R	
Reaching beyond the net	19, 53
Refereeing corps	32, 47
–Procedures	32
–Responsibilities	34, 35, 36, 37, 38
Referees' hand signals	39, 48-54
Requirements of conduct	29
Rotational fault	51

S	
Sanction cards	31, 46, 49
Sanction scale	30, 46
Scorer	36
–Location	36
–Responsibilities	36
Screening	21, 51
Second Referee	34
–Authority	34
–Location	34
–Responsibilities	35
Service	20

Sequence of regular game interruptions	25
Service order	14
Service order faults	22
Side bands	7
Sportsmalike conduct	29
Standards	8
States of play	16
Structure	6
Struture of play	13

T

Teams	9
Team composition	9
Team hits	16, 23
Team leaders	11
Team line-up	14
The toss	13
Three-ball system	8
Time-out and Technical Time-out	25
To score a point	12
To score a point, win a set and the match	12
To win a set	12
To win the match	12
Types of delays	26

U

Uniformity of balls	8
-------------------------------	---

W

Weather	5
-------------------	---

Z

Zones and areas	5
---------------------------	---



USA Volleyball®

Did you know...

•USA Volleyball (USAV) is recognized by the United States Olympic Committee (USOC) and the Federation Internationale de Volleyball (FIVB) as the National Governing Body (NGB) for the sport of volleyball and beach volleyball in the United States and is totally invested in creating volleyball as a lifetime sport for all.

•USAV nominates the U.S. Indoor and Beach Olympic Teams.

•USAV, in partnership with the USOC, sets the standard for volleyball at all levels to ensure consistent rules, safety, officiating, scorekeeping, facilities and coaching.

•USAV works to protect your children by requiring EVERY adult over the age of 18 working with junior players to have a comprehensive background screening performed every two years.

•USAV membership includes an insurance protection package.

•Your USAV membership helps support our National, Olympic and Paralympic teams in all disciplines (indoor, beach and sitting) at all levels (youth, junior and senior) in both genders.

•Your USAV membership helps “grow the game,” fostering a climate of greater understanding and friendship through the sport.

•USAV is the only national sport organization that trains coaches and officials at all levels.

www.usavolleyball.org

www.em2sports.com



OFFICIAL HOST CITY

USA Men's and Women's
National Volleyball Teams



USAVolleyball.

Men's National Team



USAVolleyball.

Women's National Team



Proudly
Supports



USAVolleyball.